

6:01 am

Friday, April 7



Term 202-2023 PPK469/01/2017(034673)

# INTERSECTION

FAT FAT ISSUE

ChatGPT

Q: "How to create a fat fat issue in two weeks?"

A: "Do a compilation of all the issues of this term."

"Brilliant."



**PAM**  
Sarawak Chapter

*Annie on Mount Kinabalu  
Photographed by Nordin (Malim Gunung)*

## FELLOWSHIP

This collection of features and articles signal the end of yet another term. Last Friday, we decided that a summing up is in order and shortlisted the material for a first draft on Tuesday. On Thursday, the fresh material was in place for the final draft – quite a rewarding sense of achievement combined with no small dose of *'shioh sendiri'*.

In the coming term, we will contribute to request for contributions and support from members. In the recent past, we have *'opened our borders'* to include contributions from outside Sarawak in an effort to be inclusive and to diversify our publications. As a result, our readership has also increased; we know this because people outside our radar have contacted us to publish in FLASH. For the coming term, we have plans to include our fellow island dwellers in Sabah and Kalimantan.

We will reach out to them in similar fashion as our local collaborators; a personal text or phone-call to a regular contributor or a new one who has recently completed a project, won an award or presented at a conference. Once there is a promise of an article, usually in the form of a Whatsapp-ed snapshot of the project and a brief description, HJ will formalize the transaction with an email listing the items to be submitted, their format and the deadline. In this manner, we are able to plan ahead for several months and amass a series of projects to feature – we try to have a main feature, a project under construction or a *'foreign'* project and finish with an ID project or student work. Contributors are sent a *'care-package'* of pastries on the following week; as a thank-you from the Chapter. This practice started during MCO and continue as part of our SOP.

We are a small team of 4; Hui Joo (HJ) is the only paid *'volunteer'* – I use that term because she regularly volunteers to help beyond her scope of official duties. She is the driving force behind this publication; reminding us of deadlines, she designs and formats, and recommends places to meet for working lunches. Pik Shia

obtains financing for our sub-committee and assists in QA/QC, Si Yong provides news for NEWS especially in relation to Practice and Government Liaison, he is key in broadcasting our digital publication to his many contacts. And me – I see my role as one of offering a platform for architects and designers to publish their work in order to gain exposure if they are young practices, and to curate their work if they are already established. When we were starting our practice (DNA) in 2000, we were encouraged and given opportunities to publish and present our work, by fellow architects - **Dr. Ken Yeang, Ar. Lee Chor Wah, Ar Ang Chee Cheong,** and the late **Fay Cheah**. This is my way of paying forward and promoting fellowship amongst peers.

Thank you for taking the time,

**Min**  
and the Fellowship of the P(r)int

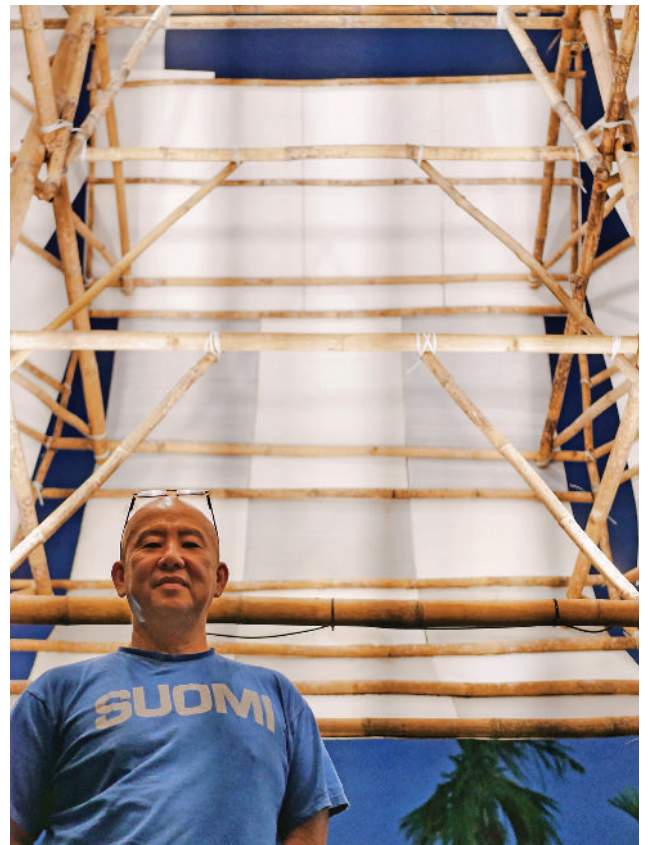

## WELCOME TO ANOTHER **FAT FAT** ISSUE !

One of the benefits for me in simplifying FLASH and NEWS into a fortnightly publication is that I only have to write my Chairman's Message once a year - and here it is. For those of you who are reading this now, thank you for your attention. LOL.

I take off my hat to the editorial team for their amazing effort in putting together all 24 issues tirelessly and always on time. As I recall, the idea usually starts during a conversation over our working lunch; Min would frame it either in writing or sketches (*sometimes on napkins*); HJ would then flesh out the format and start checking the content; while PS still has not decided what to order for lunch. I just need to make sure the final final copy is shared out by 6.01 am on that Friday morning. (*That's why you see the clock shown on this cover*)

I want to thank our partners for their support. They are **Seng Lee Glass, iMetal, Globalniaga, Kingres, Sika, UGI, Asteel, Jotun, Armstrong Flooring** and **Lysaght** (*see the last 3 pages*). Without their support, we would not be able to achieve so much.

A flashback for the term, we finally completed and opened our new PAMSC Centre at Saradise Kuching (*see page 29*) Since then, many events have been held to welcome our members back to celebrate more fellowship in person. We invited industry partners to join us for the soft launching in Aug 2023. The PAM Council Meeting was held in PAMSC Centre in Feb 2023 when many Office Bearers and Council Members outside Sarawak visited the new Centre for the first time. PAMSC Centre was officially launched by the Deputy Premier of Sarawak on 4 Mar 2023. It was a meaningful event where PAM Office Bearers and directors of Pusat Binaan Sdn. Bhd. joined us in celebrating the joyous moment.

Other than the colourful FLASH, NEWS has become a very important circular for the PAMSC sub-committees to ensure that members stay abreast with the latest information on by-

laws, guidelines, requirements, or updates on education and government agencies. Some of this information on circulars is linked with PAMSC's website for members' further reference.

Lastly, I hope this **FAT FAT** issue can be a good compilation of what PAMSC had achieved over the last term. My greatest gratitude for all your support during my chairmanship serving PAMSC and I sincerely apologize if I overlooked any matters.

Thank you.

**siyong**

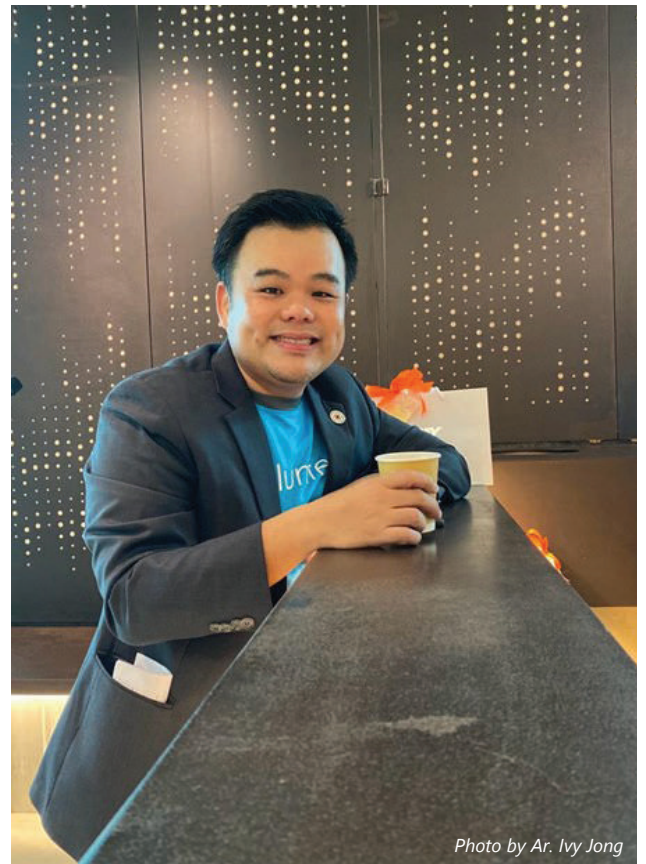

Photo by Ar. Ivy Jong

Ar. Chai Si Yong  
PAMSC Chairman, 2022-2023

In this compilation issue of INTERSECTION, we have selected several projects and as a way to re-cap the year's work, and also to thank our regular contributors for their continual support. The full feature articles can be seen in past issues of NEWS and Flash, easily available at [www.pamsc.org](http://www.pamsc.org) (REFER TO THE BOTTOM OF EACH PAGE FOR THE EXACT ISSUE NUMBER)

# ROXY TOWNHOUSE VILLA @ SEMATAN

by MNSC Architects

## ARCHITECT'S STATEMENT

Located approximately 100km away from Kuching city centre in Lundu District of Sarawak is Sematan, a picturesque fishing village with the rugged mountains behind and the majestic waters of the South China Sea in the horizon. Reachable via the Pan Borneo Highway, Sematan boasts a long and pristine beach that stretches over more than 10 kilometres, making it an idyllic vacation spot for a convenient getaway from the city.

This gated and guarded 2-storey townhouse development is made up of 4 blocks, with 68 retreat homes in total. The 4 blocks are arranged and connected via a shared central garden, which is a spacious green space adorned with footpaths spanning across the development. Unlike any typical housing, living & dining spaces are placed at the rear which connects to the balcony/terrace space overlooking the shared garden. Arranged in a zig-zag profile, the townhouse units break the linear configuration and creates a rhythmic shadow casting.

Each townhouse features a double volume external common corridor forming a linkage from the front porch to the rear open space, while creating a noise buffer from its adjacent unit. Every townhouse unit is comfortably fitted with 2 ensuite bedrooms and a private balcony / terrace space that is visually connected to the garden. With enhanced connectivity, community living in a safe and guarded vicinity is a luxury offered by Roxy Townhouse Villa.

END



Developer	: Tecktonic & Sons Holdings Sdn. Bhd.
Architect	: MNSC Architects
C&S Engineer	: Perusing JL Maju
M&E Engineer	: Alpha Beta Jurutera Perunding
Quantity Surveyor	: LSH Juruukur Bahan
Design Team	: Lau Ming Ngi, Kong Yean Wei, Hii Wei Sheng, Tiong Chiong Kei



# SARADISE FEAST

by IDC Architects Sdn Bhd

## ARCHITECT'S STATEMENT

Food courts can be a bit of a cliché nowadays. There is one or two in every shopping centre, and the concept is usually quite generic – i.e. a ring of individual stalls surrounding a common dining area. Nevertheless when we were approached to design the Saradise Feast, a food court within the Saradise Edge F&B Hub – we were very excited by the prospect.

Saradise Edge is a dedicated F&B development within the 3-year-old Saradise Commercial Centre, which has established itself as one of the most popular F&B destinations in Kuching. This first of its kind development consists of 2 blocks of 3-storey commercial lots with a covered mall in between. The Saradise Feast Food Court is located within this ground floor covered area. The layout is aimed at creating a food street concept, with stalls on both sides and the dining area in the centre.

The Client's overall vision for Saradise is to be "The Heartbeat for Kuching". It aims to unify Sarawak's Identity, Ecology and Art to transform the quality of life for Kuchingites. Therefore the Food Street concept needs to tie into this overall theme, and develop a concept that has strong linkage to Sarawak's history, culture and craft traditions.

Developing on the idea of the Food Street, the main concept centres on the urban street idea. The Colonial History of Sarawak, with familiar old shophouses on Main Bazaar and Carpenter Street serve as inspiration for the main design backdrop, which is the shopfront treatment of the food stalls that are decorated to reflect the old shophouses and remind patrons of Sarawak's rich Colonial history.

In the centre, the columns are decorated with curved timber strips – which borrows from the split-bamboo decoration used in longhouses during festive occasions (*traditionally called Piring*).

The Ceiling of the food street is decorated with wood-framed panels in-filled with traditional rattan mat, and covered with Perspex printed with traditional ethnic patterns.

In the air-conditioned dining space which occupies a ground floor commercial lot, the ceiling is decorated with painted steel pipes, arranged to form a basket weave pattern. This space also functions as an art gallery showcasing local artists. The entrances to the air-conditioned space at the front and rear are framed by wooden tunnels, finished with laminate, rattan, mirrors and strip light, function as time-tunnels connecting the indoor and outdoor spaces.

On the whole, the dining spaces are zoned into separate areas which slightly different treatments to offer a variety of spaces. Tall communal tables and stools in the centre street provide an informal space for casual catch-up. Low partitions at the back section provide some privacy for those who prefer quieter corners. The air-conditioned area provide a respite when it is hot and humid outside.



Client	: Saradise F&B Sdn Bhd
Architect	: IDC Architects Sdn Bhd
Project Team	: Project Architect - Ar Ng Chee Wee Graduate Architect - Mr Liaw Kheng Boon Technical Assistant - Mr Ivan Kong
Contractor	: Eden Atelier Sdn Bhd

# KINDERGARTEN & DAYCARE CENTRE

@ KELAB KIDURONG BINTULU

by INTODESIGN Lab

A kindergarten is a place to learn through play whereas a daycare centre cares for young children for the duration of an adult's work-day. Many of us remember our first experience of early childhood education as a less than enjoyable one, for some it was a fearful departure from the familiar and 'safe' environment of home.

This was our main design objective when we were commissioned to renovate the former international school in Bintulu. We aimed to 'rescue' the children from this situation by creating a scheme that is able to leave a positive lasting impression for the children. In child psychology, good impressions help to develop relationships to a place - a positive first impression often leads to cohesion, which grows into familiarity that eventually becomes a sense of security in the child.

We drew inspiration from the activities of the town and people, and extracted many elements from this industrial oil and gas town and adapted their forms as playscape in the courtyard. So that the kindergarten will bear impressions of Bintulu. Similarly, Sarawak's lush forests and natural environment were reflected in the interior spaces - to modulate the learning environment, to calm their minds and spirits and hopefully leave a good memory for their future.

Text by Lam Choi Suan



Group photos of the Kuching consultants' team during the handover inspections, this was a dedicated and cohesive team that delivered excellent project; a good one for their portfolio.



A nice spot to pose for photos before the slide is installed to the folly.



Next to the Baby Room, is the connecting "wet land concept" Toddler Room with toddler friendly design furniture, all the corners are curve edges.



Dual frontage platform stage serves multiple functions. The panels are the stage screen on one side but to be the backdrop on the other side. The classrooms are extended further when the sliding panels are opened. 'It is perfect for family day' the clients were delighted with the idea



Project	: Kindergarten & Daycare Centre
Client	: Malaysia LNG Sdn Bhd & Kelab Kidurong Bintulu
Interior Design & Build	: INTODESIGN Lab
Submitting Architect	: PDC Design Group Sdn. Bhd.
Playscape	: INTODESIGN Lab
Design Team	: Tay Tze Yong, Lam Choi Suan, Liew Pei Yin, Tay Siew Wen
Project Team	: Lam Choi Suan, Sim Siok Pheng, Jong Si Hong
Consulting Civil & Structural Engineer	: Perunding K.S.L
Consulting Mechanical & Electrical Engineer	: Alpha Beta JP Sdn. Bhd.
Quantity Surveyor	: Porticode Sdn. Bhd.
Contractor	: Hong-Yet Constructions Sdn Bhd

# RIAM INSTITUTE OF TECHNOLOGY, MIRI

by James Sie & Associates

## ARCHITECT'S STATEMENT

Riam Institute of Technology (RiamTec) started with a humble beginnings some 20 years ago as a vocational college, sharing its compound with the pre-existing Riam Road Secondary School. Over the years, the Institute evolved and thrived to become a renowned centre of higher learning based on the culture of learning by doing.

This featured building is RiamTec's new administrative block; an architectural design specifically tailored to 'showcase' the institute to the city. Placed majestically on the edge of an existing sports field, the five-storey building is strikingly visible to passers-by of Jalan Riam.

As it is an infill development, the building is constructed above an existing road and carpark. The main floor sits on a plinth that connects directly to the existing classroom block behind via a sky bridge. Its curved façade embraces the view of the field like wings that reflect the institute's vision for its students to soar to greater heights.

This administrative block also houses a multi-purpose hall and laboratories among others, gives emphasis to its relation with green sports field. The amphitheater styled seating at the building's main entrance is aligned to the running track and provides optimal viewing experience. Equally notable is the sprawling curtain glass frontage that brings forth generous greenery view to the interior space. A series of lattices are used to filter the sun penetration along the double-volume open corridor at the centre.

END



The curved building's façade embraces the view of the school field.



A new bridge that connects the existing classroom block with new admin block.



Open corridor and staircase design with views through the lattice façade.



Building with amphitheatre step seating design alongside the existing 100m running track.

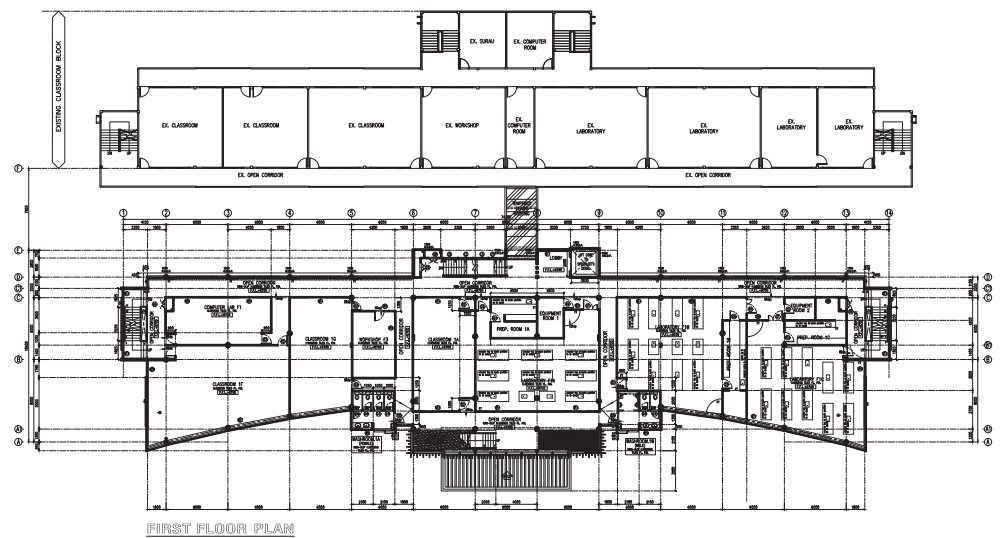

FIRST FLOOR PLAN

Architect :  
James Sie & Associates  
Design Team :  
Chin Chee Hong, Andrew Wong,  
Chin Jun Liang, Eveline Yoong  
Client :  
Riam Institute of Technology Miri  
Quantity Surveyor :  
ELP Quantity Surveyors (Sarawak) Sdn. Bhd.  
M&E Engineer :  
Perunding CH Engineering Sdn. Bhd.  
C&S Engineer :  
PCS Konsultant Sdn. Bhd.  
Builder :  
Green Summit Construction,  
Sukiada Engineering (Sarawak)

# MICROLIVING CATALOGUE, SELANGOR

by Ar. Daniel Tiong Wei Wen

## ARCHITECT'S STATEMENT

The current context of small apartment unit in Kuala Lumpur is limited between 550sqft-600sqft and this typology has existed for decades, targeted for single bachelor or newly wed couples which limits the adaptability of the space for the increase in household members; and once a family grows in number, they will have to find a bigger space to accommodate their living needs.

Microliving Catalog is an experimental project located in Kuala Lumpur to rethink the spatial configuration in conventional small apartments by using affordable local materials and methods to allow for a more spacious and humane micro living.

All major furnitures such as dining table set, sofas and tv consoles are replaced with single continuous raised platform with the intention to bring all interactions closer to floor level. Reflecting on the Malaysian's childhood memory of living-playing-reading-sleeping on the floor of a verandah, an area which activities is cooling and promotes intimacy and interaction among family members. With the introduction of the continuous platform, each corner of the space become usable and flexible for any form of daily activities and there is no fixed demarcation of the function as the whole space is fluid in term of access and use.

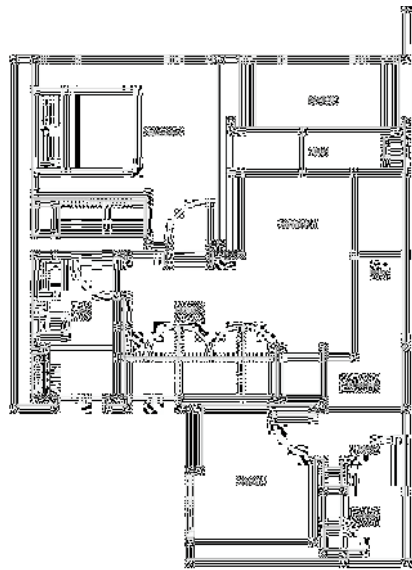

The centre courtyard-like space is an ambiguous open atmosphere of indoor-outdoor experience with the materiality of plywood serving as the binding element to integrate seating-table-walkway-steps into a singular language. This allows for expanded flexibility for more usage and adaptability, either for a growing family or hosting for a large group of people which is not possible in conventional small apartments. From the continuous platform, one is able to walk up onto the window deck or become a small two tier theater seating.

Walking up the platform is the conventional bay window with Air conditioning services underneath, which turns into a floating pavilion framing the full-height view into the cityscape. All plywood edges extended by 25mm to eliminate odd joinery detail while expressing the true thickness of plywood and the plywood also helps to insulate the noise and vibration from the air conditioning units.

Each interior elevation is extended through the play of depth such as extension of timber framing, linear decking-backrest, and mirror wall reflection. These elevations frames different functions-meaning such as entrance frame: traditional Chinese archway mark the entrance, bay window frame: floating pavilion, raised platform: pathway-seating in garden, mirror wall at kitchen: spatial continuity.

END

Project name	: Microliving Catalog
Architectural Designer	: Ar. Daniel Tiong Wei Wen
Location	: Selangor, Malaysia
Area	: 581 sqft
Year of completion	: 2022



# DESIGN BY SPATIAL & PROPORTION MANIPULATION: A FANCY APARTMENT WANNABE

by Wong Zi Tao

## ARCHITECT'S STATEMENT

The design was pretty simple: the first move was to rotate the unit layout so that the sleeping is furthest away from the MRT tracks. Created a buffer zone for plants and laundry, which also makes up for the balcony-less unit. With the buffer zone, there was an opportunity to create a secondary façade that I have full control. So, I took the opportunity to adjust the wall-to-window ratio so that it feels less of a generic flat. For privacy and a touch of design, splurged on mild-steel and fluted glass, which proved to be a good investment.

Spatial wise, I needed to address the low ceiling height of the unit, which is barely 2.4m to soffit, and less below the beams. Hence, there was a decision to keep spaces as wide and as deep as possible.

So, for living and dining room, I picked 'width' as the dominant dimension for the space: to put it simply, the TV is not too far away, and still have ample of space on both sides.

For the master bedroom, the door is relocated to make full use of the space for storage and wardrobe. Design of the cabinetry is kept simple to keep the sleeping environment calm and muted. Draping with full height curtains helps to further keep the acoustic level low. For the Secondary/Guest Room, the consideration is not to have a bed perpetually laid out on a daily basis, but only pull down the murphy bed when required. Instead of applying another layer of fluted glass at this glass partition, the fluted panel transfer the vertical lines to the back of the room.



END

*TAO first came to Kuching during his year out between his Part I and II, and joined as a volunteer with Habitat for Humanity Kuching. He spent 3 months working as an assistant site supervisor to the foreman: teaching international volunteers how to mix cement, plastering and lay bricks. Through a chance encounter, he began his internship at Design Network Architects, under the mentorship of Min. His connection to Sarawak extends beyond Kuching when he was tasked to design an urban timber structure for the plaza of Sibu Heritage Centre. To date, he has built approximately 6 houses, 1 urban timber deck, and many friendships in Sarawak. He is currently part of the design management team for Singapore's Changi Airport Group Terminal 5.*

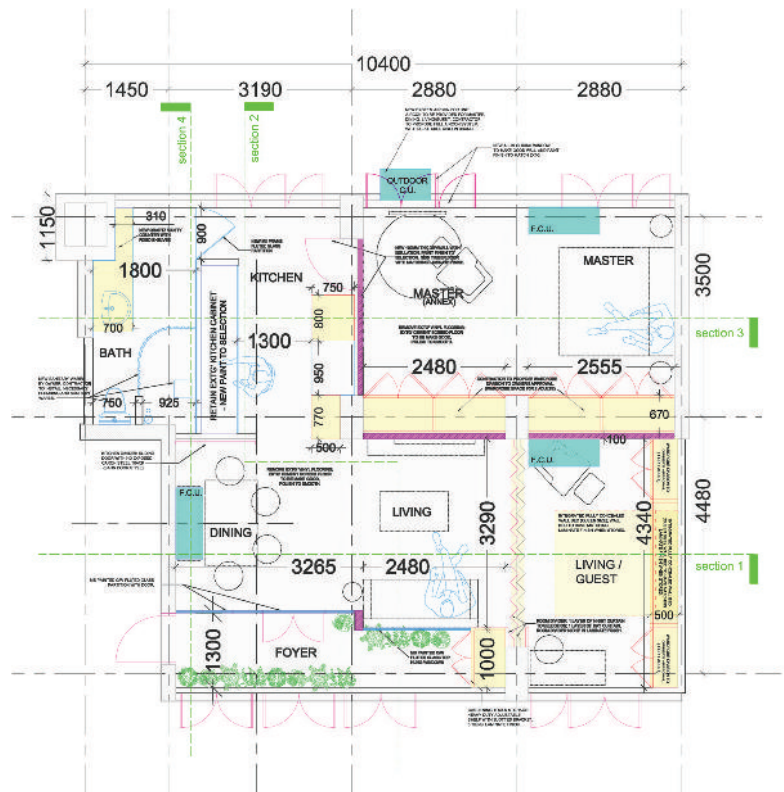



**CAT HOUSE**  
 @ BATU PAHAT, JOHOR  
 by Basic Design Workshop

**ARCHITECT'S STATEMENT**

A small shelter of 16m<sup>2</sup> designed to accommodate up to over fifteen stray cats.

Modular design: 45cm x 45cm x 90cm basic unit stacked and assembled following certain rules. Some of which are "solid", some are openable, consists of 13 types and 51 boxes in total. Seat for caretaker, storage for food and tools and the most important: rooms for cats to stay and play are all made up of these

modular wooden boxes, with careful placement of different type of box at certain location.

All boxes are made of solid wood. Wood panels are cut to size with CNC technique at local wood furniture manufacturer, pre-assembled in factory, and installed at site box by box.

Fixed glass louvers are installed to provide fresh air.



谢诗奇  
 Chia shi Chee



谢诗晨  
 Chia shi Chen



唐明生  
 T'ng Meng Seng

Co-founded by **Chia shi Chee**, **Chia shi Chen** and **T'ng Meng Seng** in 2010, **Basic Design Workshop** is a small practice of four based in Batu Pahat, Johor. Our projects range from master plan and architectural design for schools, houses, extensions to interior design including furniture and lighting design.

**STUDYING**



**MANUFACTURING**



**INSTALLING**



# LITTLE BLUE PROJECT

by INTODESIGN Lab

## ARCHITECT'S STATEMENT

As we all know, cleanliness is important within the school compound, aside from common areas like the classrooms, canteen, corridor and etc, the toilets with high usage are equally important. In our numerous visit to the urban schools, as we observed, there are common problems with the toilets, which are due to a lack of cleanliness, maintenance problems, and vandalism committed by students.

Averagely, students spend around one third of their time at school and they need to use the toilet rather frequently. A hygienic toilets provide healthy environment by minimizing transmissible diseases, encouraging good attitude and cultivating sense of responsibility to the students. On the contrary, dirty toilets will cause sickness, disgust and a bad impression or memory for young children. This is because school is the first public space they step into away from home. A clean and well designed toilet can cultivate good habits and social responsibilities since young age.

I came across an interesting news in China Daily News where students at a primary school in Fuzhou, East China's Fujian province, were reportedly required to take the responsibility to clean the school toilets to help them nurture healthy habits. Some parents opposed the idea, but others believed that the kids who were instructed to clean the school toilets would thank the school later for instilling the spirit of rules and teamwork in them.

In this little toilet project at CHPS No.1, I took a chance to redefine the toilet cubicles at a local primary school with natural ventilation, brighten the interior spaces with natural lighting, and utilize rainwater collection for cleaning, gardening, and outdoor activities. Contrasting to most toilet in urban schools, the toilet corners are fillet to create a softer form. There is certain playful manner in the space planning, thus resulted in a non ordinary appearance. I choose to use the pastel blue color as a tribute to the school's color theme. Since its completion, it has drawn attention to the teachers and parents, students are happy to gather there as a pick up point after school.

I hope this Little Blue Project will inspire other schools to promote healthy toilets and encourage students to develop healthy habits. For me, even a small voluntary project is worth attempting to make it as impactful as possible.

Text by Tay Tze Yong

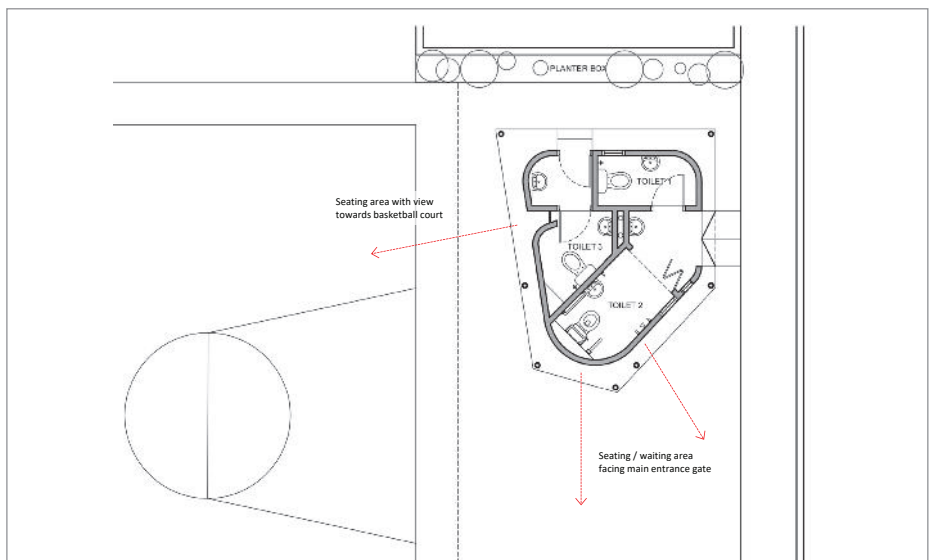

# T HOUSE BY DESIGN NETWORK ARCHITECTS

Gold - Single Residential Category, PAM Awards 2022



## Q & A WITH AR. WILLIAM KHOO

F: Flash    W: Ar. William Khoo

**F** : *This is not the first time DNA had won Gold at the PAM Awards in the Single Residential Category - when do you know that a project has a chance of winning a prize? Is it something that you strive to do at the beginning of each project?*

**W** : Every project has a story to tell, that narrative is often stronger when it comes to one's own house. Architectural projects being idea-centric has merits when a narrative is well developed and carried through the project's inception and execution.

Ultimately we want excellence in our projects but that driving factor often is not benchmarked solely by an award. However there are some indicators when a project has a little extra "oomph". For example, client chemistry, unique sites, extraordinary contextually briefs or requirements or even tight budgets. Things that often present a challenge or create tension becomes an architect's playground. If all the cards align, we usually will have a better sense if the project will have a spark after construction commences. If the details are executed well and the design intents are preserved or followed through, we then develop what we would call an "inkling".

**F** : *The award must mean a great deal to the team who worked on the project, what do you think it meant to the house owners? Did you discuss this with them?*

**W** : Winning an award really is to honour the hard work of everyone involved. It has always been a team effort. The client being essentially the patron has one of the most pivotal roles. Our role as an architect is to translate a client's narrative through the means of design, so the boldness and trust that a client would need to place upon us is crucial for us to do work that pushes boundaries.

**F** : *What is the client's role in winning this award?*

**W** : In the case of Teresa's house, she really was the narrative, her journey of personal development embodied the personality of the project. Her home being uniquely designed to reflect her personality, heritage and love for nature. Ultimately it is her story that encapsulated everyone, the house was the medium in which it was told. The win is much credited to her.

**F** : *Does winning this award mean that more people will be seeking you to design and build their houses for them? And is this a legacy you see for yourself?*

**W** : Awards definitely work for branding, that's sort of one of the many positive responses that come with it. However, it has never been the main reason we participated. Even in our early formative years of DNA, the awards submission were our way of documenting our projects for future showcase. We wanted an archive that we could reflect on and intuitively look deeper into our intentions. It felt almost like an architectural diary.

As for legacy, I believe I speak for the team that we want to continue pursuing excellence. We hope to leave a legacy of many more younger architects that will continue to push the boundaries of their craft, that will love and respect architecture as truly an art form and that great buildings can come out of anywhere, even Sarawak. You are not defined or limited by your environment.

END





# ALONE.TOGETHER

## A Crowdfunded New Norms Park

### Commendation - Special Projects Category, PAM Awards 2022

We first featured this crowd funded project on the 14<sup>th</sup> of August, 2020, so it is to our immense pride that this local project won an award at the PAM Awards 2022 recently, especially when it is a project by two young architects - Ar. Goh Tze Hui and David Boon. We met up with Tze Hui to gain an insight into this project and their current work.

### ARCHITECT'S STATEMENT

*Written by David Boon & Goh Tze Hui*

In 2020, at the peak of the Coronavirus pandemic, during the Movement Control Order (MCO); like a majority of Malaysians nationwide, it was also our first time working from home.

I remember clearly that it was a Wesak day afternoon. We were having a conversation on how the pandemic has redefined our roles as architects, the designers of the built environment. That conversation went on to spark the defining discussion on what we, as young professionals under mentorship, can do to develop and provide something for the community in the New Normal.

To us, architecture is a form of functional art, where its beauty is derived from the narratives associated by the community that it serves.

We designed a public installation that explores how architects, designers of the built environment, can raise awareness on environmental sustainability whilst encouraging outdoor activities; and to stay safe through promoting good design in facilitating proper social distancing. Imbued with symbolism and life; the installation is a grassroots movement, a project by the people, for the people.

With the design in one hand, and its narrative in another; we pitched our idea to our Mayor of Kuching City South Council, that we will volunteer our time, resources, and develop the design from the installation's inception to conception on a pro-bono basis. Under the patronage of our Mayor, the project was born!

Our Mayor launched a ground-breaking crowdfunding drive through social media, which exceeded its crowdfunding goals in less than 24 hours! It is a testament of collaborative joint endeavour between the architects, and the local council; with strong support of the community.

Following through with the successful crowdfunding, we secured sponsorship from Trans Paint Sdn Bhd, a local paint manufacturer; and facilitated the engaged fabricator, Wan Li Wan Welding Works, in material procurement.

We managed the coordination in its entirety between the fabricator, painter, and council officials through the entire process which ranges from detailing, mock-up prototyping, off-site fabrication, installation on site, and landscaping works.

To encourage thoroughness and transparency, we have also created a regularly updated blog (<https://arkitekjfn.blogspot.com/p/new-norms-park.html>) that documents the entire process from initiation, delivery, and beyond. A plaque bearing an engraved QR code has been installed, linking patrons with access to the documentation and to an online space to continue discussion and conversations.



*The bold striking colours and unique form of the installation makes it a popular check-in spot for park regulars and visitors alike.*



*Crowdfunded under the Mayor's patronage, this installation demonstrates public and private joint effort.*



*Installed in the centre of the installation is a QR code engraved on a plaque providing information of the project from initiation to delivery.*

# Q & A WITH TZE HUI GOH

F : Flash T : Tze Hui

**F** : ***Congratulations, this is not the first time Arkitek JFN has won PAM Awards - but we believe this is your first time. Tell us what this means to you personally, does it make you strive for more awards in the future?***

**T** : This award is definitely momentous for me, and is a huge encouragement from the Architecture fraternity for us to continue striving to deliver good design and to promote the same to the community.

**F** : ***What does this award mean to your team? Do they share your joy?***

**T** : The team is delighted to receive this joyful surprise, as we did not expect to win, let alone with a small project budget of less than RM 12,000. This award means a lot to the project team, as this is their first time participating in an award-winning Architecture project.

**F** : ***What is the client's role in winning this award?***

**T** : The actual Client for this project is the public, who have supported and funded this project, through our crowdfunding drive via City Council of Kuching South (MBKS) Mayor's Facebook livestream.

MBKS as the owner of the site has taken up the role to prepare the site, implement the soft landscaping, provide security and ongoing maintenance of the installation.

**F** : ***Does winning this award mean that more people will be seeking you to design and build projects of a similar nature?***

**T** : Previously, we have self-initiated community engagement projects of similar nature, to advocate for heritage conservation and awareness.

With public interest always in mind, we find that projects in this vein to be quite fulfilling, and look forward to do more as the opportunities arise.

**F** : ***Is there another award winning scheme on the drawing board at the moment?***

**T** : We treat each of our projects with reverence, but winning an award is not just up to us.

It requires good rapport with a client who is open to ideas, good site context that allows narratives to develop, so that there can be opportunities to push boundaries; and proper execution of the works.

I suppose we can summarise it with the Chinese Proverb “天时、地利、人和” (*when heaven and earth align, man prospers*).

We are currently working on some interesting projects, and you may read about it soon from our blog <https://arkitekjfn.blogspot.com/>

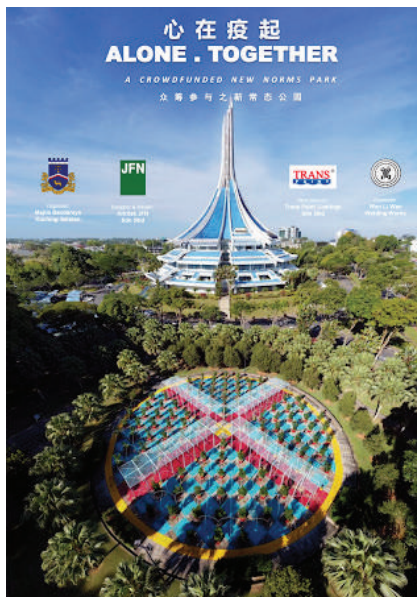

END

# BEHIND A SUCCESSFUL PAM AWARDS SUBMISSION

by Ar. Arlene Chew

Arlene Chew is behind many successful PAM Awards submissions, recently her Keranji House was shortlisted for an award in the Single Residential Category. We reached out to her for some insights behind a successful PAM Awards Submission.

**M**y experience with the PAM Awards started 2 decades ago when I was at my previous office, Design Network Architects (DNA). Every year without fail, the office would gear up for 'Pam Award Season'...a period of two to three months where everyone juggled submission work with in their already busy work-life schedules. We contributed the best we could to 'celebrate' projects through PAM award submissions. It meant sleepless nights, bottomless coffees, endless hours staring at screens, stress, and having lots of fun...now thinking back. It was rewarding, especially when the projects win something. If not, everyone was a little wiser and we would all go back to our routines until the next season came.

Recently, in my new practice, SML Architects, we started this culture again through our first submission 'Keranji House' and were delighted that we were

short-listed at first try. So being a veteran to PAM award submissions, I'm now sharing my personal experience on what happens behind a successful submission.

## WHY PARTICIPATE

Just in case anyone reading this has no idea what the PAM Awards is, the PAM Awards is the 'highest recognition for architectural excellence' in Malaysia for Architects, Clients/Owners and Builders/Contractors. So, participating and winning is a big deal.

Participating also allows our work to be judged and recognised by our own peers. In addition to the Architect, the award is also given to the client and contractor. Winning is a great way to promote and publicise work to the public locally and internationally. Successful submissions are exhibited and automatically published in the widely circulated Architecture Malaysia Magazine.

Even if we don't win, submitting is a good way to 'force' us to document projects comprehensively and then this material can be easily published on websites, social media, work portfolios and other printed media.

## CREATING POTENTIAL PROJECTS

Everything needs to start with a clear intention. Usually, the goal we set for any project is that it needs to be good enough to be publishable; something we can be proud of to show and tell. A publishable project is a good gage of whether something is a suitable candidate for an award.

With that mind-set, the work that is put in at the inception of a project is meticulously carried through the whole process of creation to realisation. This also assures that there will potentially be a consistent range of projects that is also submittable for architectural awards.

## FLOOR PLAN FIRST FLOOR PLAN

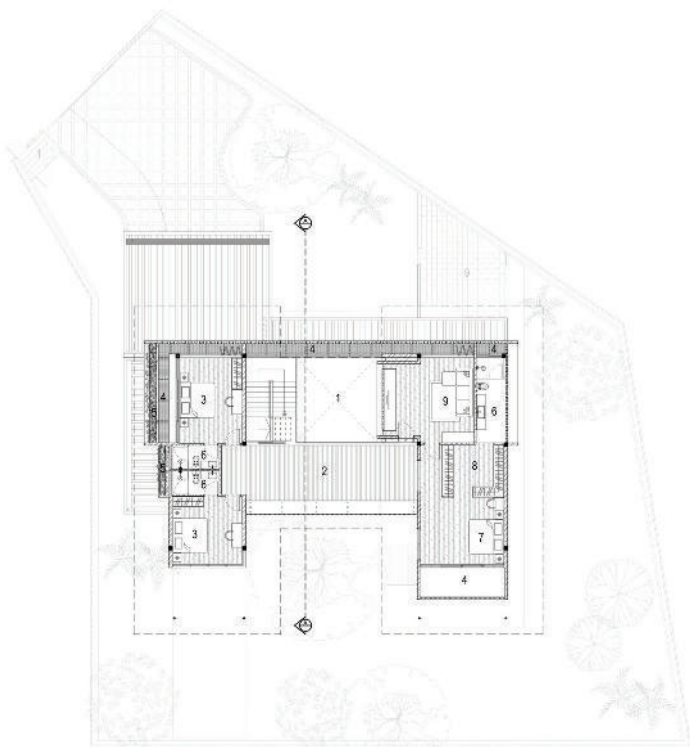

### LEGEND

- |                     |                    |
|---------------------|--------------------|
| 1 VOID OVER KITCHEN | 6 WC               |
| 2 OPEN FAMILY DECK  | 7 MASTER ROOM      |
| 3 BEDROOM           | 8 WALK-IN WARDROBE |
| 4 SCREENED GALLERY  | 9 FAMILY ROOM      |
| 5 PLANTER           |                    |

FIRST FLOOR PLAN  
SCALE 1:200

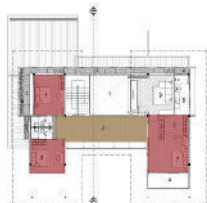

On the first floor, the Master Pavilion, houses the master-suite while the second pavilion houses two bedrooms for their two visiting children or guests. The two pavilions are then connected through shared soft breathable links of shaded terraces, open walkways and galleries on all levels. One is intentionally made to step into these shared spaces when transitioning out from one's private domains. This is where family members and friends meet to gather, to connect, to play, to eat, to feast and to relax.

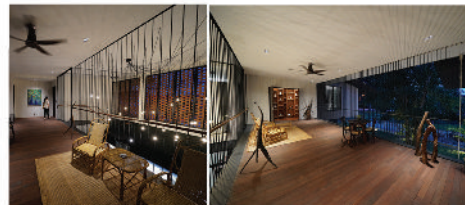

Naturally, here lies the heart of the house: a central double-volume kitchen with a 'floating' staircase, flanked by open decks on two floors. All are welcomed here, including the natural elements ... rain, wind or sun.



Behind the veil. The faced bricks provide shade from the sun, privacy to look out to and a changing play of light and shadow into the spaces behind. Louvre windows invite a continuous flow of cool air throughout the house, drawn by cross-ventilation and the variation of volumes within the house.

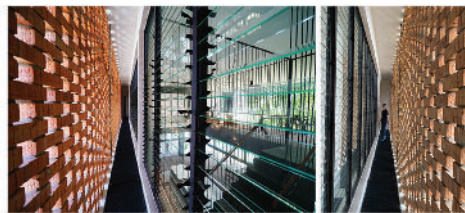



## BUILDING THE NARRATIVE

A strong, believable and gripping narrative is one of the main ingredients for a successful submission. During the design process, conceptual sketches and ideas are generously shared with the client so they are always included in the creative process. It is always a bonus when clients start sketching back and getting excited with ideas. This conjures an invaluable sense of shared ownership for the design and often helps the product to reflect the original design intentions.

During construction, the contractor's input is also valued, and we are always open to different ways to thinking and making things work better. In all this, we always discipline ourselves to keep good records. All the collected sketches, notes and photographs will eventually help build depth, character, and add soul to the overall project narrative.

## OPENING THE DOOR

Once a suitable project(s) is chosen, the next most important step is to make sure your project gets short-listed. This is where most of the submission

work happens and where we put in the most grind. The main goal here would be a submission that grabs the jurors' attention and subsequently convinces them that the project has enough merit to be selected.

Taking very good photographs and selecting the right ones are key. For us, all photography are done in-house although professionally photos can be an option. We always ensure we include a handful of drool-worthy 'killer shots' that seduces the viewer, a few other shots that capture the design intent, the spatial experience and if possible, some with people inside (especially with pets for houses) and some site-photos. The idea is to weave the narrative and the photos so they catch attention and tell the intended story.

Finally everything needs to be put together into well composed presentation panels, explanatory reports and other submission materials. Internal crits and countless pin ups were done days and nights until we got everything just right.

## MAKING IT

Once a project is short-listed, there will be another round of submissions for final judging. Before results are finalised, an independent technical reviewer will be appointed to visit all projects, record and verify the work. Here we'd bring them around the building and answer any questions that might arise. As the reviewer will also be required to review the project, this is a good chance to impress as much as possible.

At the end of the day, the actual product needs to live up to the story and pretty pictures. The building needs to excel at all levels and work for the users. The whole judging process takes this into account.

I would encourage everyone with a worthy project to give it a go. Sarawakians have consistently done well at the PAM Awards and we should therefore be proud to push and showcase our work when given the chance.

END

## SUSPENDED STAIRCASE

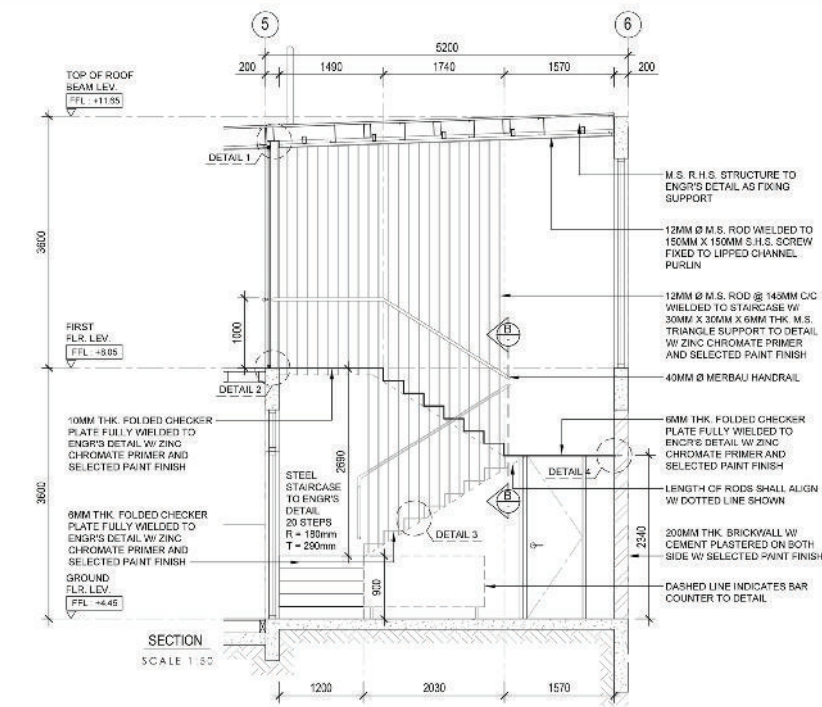

A double-volume kitchen sits right at the centre of the house. The heart of the house where all pass and gather as they move through.

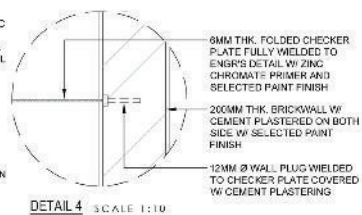
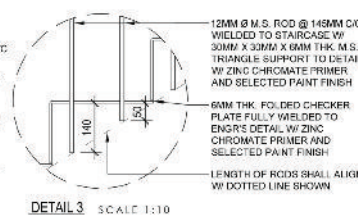
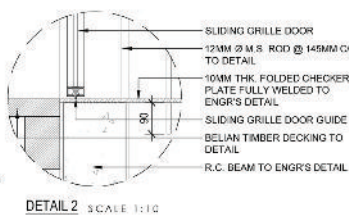
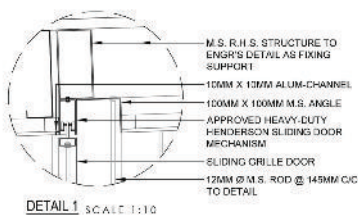

Example of submitted page.

# PAMSC WORLD ARCHITECTURE DAY CELEBRATIONS – A CHRONOLOGY

Our WAD celebrations will be making a comeback later this year after a hiatus of two years - this is a look back at our past celebrations.



## 2011 Architecture and Human Rights

Location : Spring Mall  
Event : Cardboard City

An installation recycling cardboard boxes to create a shelter to depict the plight of the homeless, built by architecture student in a shopping mall overnight.



## 2012 Architects are City changers

Location : Boulevard Mall  
Event : WAD 2.0

A 2-stage competition for official event tee-shirt and urban installation, open to high school and design students, with final design built and exhibited at a local shopping mall.



## 2014 Healthy cities, Happy cities

Location : Love Gallery, Jalan Padungan  
Event : WAD 4.0

Competition and exhibition of winning entries for urban installations, as well as graduate architects' portfolio carried out in a local art gallery.



## 2013 Culture - Architecture

Location : Tun Jugah Shopping Mall  
Event : WAD 3.0

Design competition and exhibition of installations with judging carried out by prominent local designers and personalities, with a category for online voting via Facebook.



## 2015 Architecture, Building, Climate

Location : Padang Merdeka and Plaza Merdeka  
Event : WAD 5.0

A 24-hr design workshop to design a pavillion to commemorate the life of Tom Harrison; renowned local historian and polymath. The winning entry was constructed and exhibited at the Padang for a fortnight.



## 2016 Design a better world

Location : The old Courthouse, Kuching  
 Event : WAD 6.0 24-hr Design workshop

Students from local universities and design colleges were given 24-hr to come up with design solutions for urban intervention schemes, judging was carried out the following day by prominent local architects and speakers from the PAMSC Public Design Lecture Series.

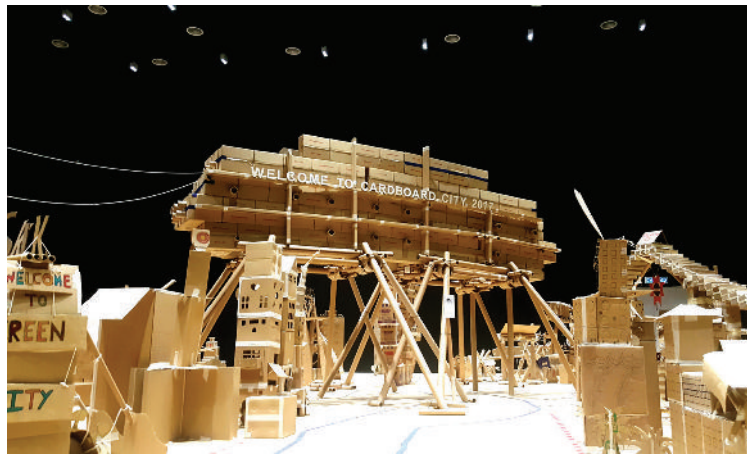

## 2017 Climate change action

Location : Borneo744  
 Event : WAD 7.0 Cardboard City Challenge

Building of an imaginary city using cardboard by students from local schools, coordinated by local design firm INTODESIGN LAB and their design students. The 'city' was then opened to the general public as part of a design festival.



## 2018 Architecture for a better world

Location : Kompleks Belia dan Sukan  
 Event : WAD 8.0 Cardboard City – 'Re-imagining the future'

A continuation of the first Cardboard City – This time targeted to younger school children and their families.



## 2019 Architecture – housing for all

Location : Ting and Think Event Space  
 Event : WAD 9.0 / WAK (What About Kuching)

A joint event with organiser of WAK - a walking tour and roving exhibition of local architects' works, culminating in an exhibition/ installations and design talks at Tink and Think; a re-purposed supermarket in Kuching.

# MOON MISSION : Realising urban resilience through art and design installations

Written by Tay Tze Yong

COVID-19 affected the lives of many people around the world. We are now two to three years after the pandemic, the question now is **what's next for our city?** Should urban development follow the path it took before the pandemic hit? I really think our city should be allowed to freely re-imagine possible futures and experiment with more sustainable and creative ways of life. At the very least, local communities, creative and cultural organizations should be encouraged - should be allowed to create spaces that inspire the creativity in the city's dwellers.

To this end, PAMSC's World Architecture Day (WAD) celebrations have become a 'testing ground' to promote creativity, and to re-imagine our future cities. In the past, we have taken the opportunity to work closely with PAMSC to organize events such as Cardboard City, the 'Walking City' and other installations involved in efforts to foster creativity and sustainability within local communities, particularly among the young generations.

In conjunction with this year's WAD 2022 celebration - the temporary installation of Moon Pavilion has been set-up in the public park at the Palmerium, MBKS (Majlis Bandaraya Kuching Selatan). This place-making project also aims to promote cultural event through celebration of Mid-Autumn Festival (Mooncake Festival), promote community engagement and celebrate endemic. We foresaw that it could serve as a backdrop for lectures, mini concerts and night movie screenings in the park. Aside from PAMSC, the event was a combined effort of MBKS, SCACA (Sarawak Creative Art and Culture Association) and FECCA (Free & Easy Chinese Calligraphy Association).

The concept of the Moon Pavilion was derived from the poems of Song Dynasty:  
At Lantern Festival - Tune: Song of Hawthorn by Ouyang Xiu (欧阳修): <生查子·元夕> 之 '月上柳梢头, 人约黄昏后' - **'When the moon hung behind the willows, young people went out on dates under them'**. This verse aims to illustrate the artistic conception of Moon Pavilion during the Mid-Autumn Festival.

The design process for the Moon Pavilion was also inspired by the Serpentine Gallery by OMA - 'The centrepiece of the design is a spectacular ovoid-shaped inflatable canopy that floats above the Serpentine's lawn. Made from translucent material, the structure is illuminated from within at night. The canopy will be raised into the air or lowered to cover the amphitheater below according to the weather' ([www.oma.com](http://www.oma.com)).

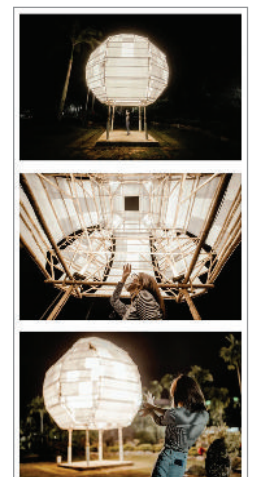
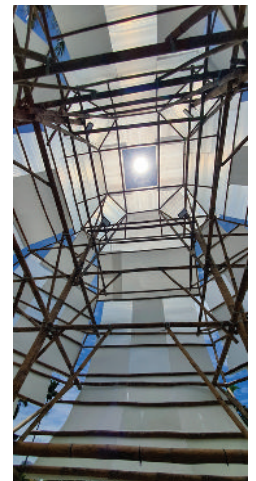



## DIAGRAMS & MODEL

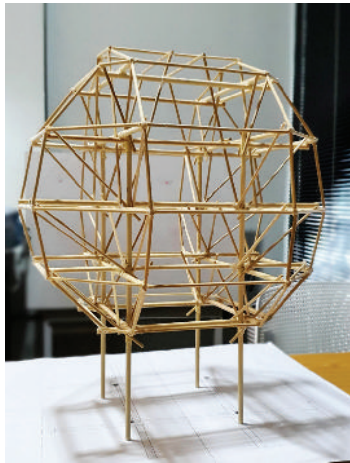
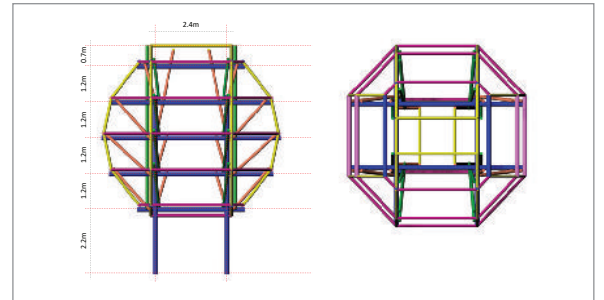
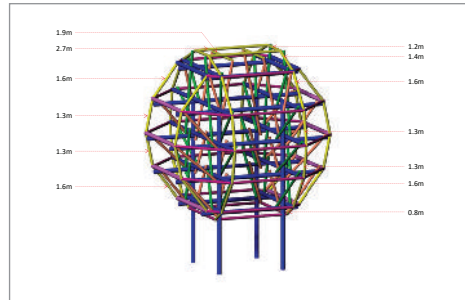

We envision the Moon Pavilion to be simply a white spherical object floating in the park. It would be translucent in the day with shadows cast from the internal frames, and illuminated at night. It can be seen from the main road or within the park, intentionally creating interest for the public. Some children claim it is a Star Wars spaceship ready to take off, a Kongming lantern, big eggs, a lantern that you can hide in, etc. . . it can be interpreted in any way. Most importantly, to connect architecture, art installations, and creativity to the local community.

In terms of building materials, the structure is made of bamboo, just like traditional lanterns. Bamboo was harvested and cured earlier in August by the skillful Bidayuh community from Puncak Borneo. It took a month from harvesting to installation in the park.

There is a one-day university students event held at MBKS Auditorium and Palmerium Park in the midst of the Moon Pavilion construction - 'PAMSC WAD 2022 : The Moon Pavilion Installation & Students Workshop'. The event consisted of a bamboo crafting workshop, bamboo design lectures led by Dr. Bambang Karsono and Cr. Wadel Boyod, site visit and installation of the Moon Pavilion. This event was participated by 110 students across five universities in Sarawak (UNIMAS, Swinburne University, UITM from Kuching, Kolej Laila Taib and UTS from Sibiu).



Kuching has a rich and diverse culture and community. Our heritage is made up of the tangible, the intangible and the natural. Ultimately, we might consider what we could do next to ensure that the city's development allows organic intervention in creative, cultural and community spaces. We could also re-imagine what our city needs in the near future. With that in mind, it is hoped that the Moon Pavilion will continue its mission to inspire.

END

### MOON PAVILION PROJECT

Designed by	: INTODESIGN Lab
Design team	: Tay Tze Yong, Lam Choi Suan, Sim Siok Pheng
Structural Engineer (Foundation)	: N.D. Konsultant
Foundation Contractor	: Precious Buildlility Construction
Bamboo Installer	: Bidayuh community led by Cr. Wadel Boyod
Supported by	: MBKS, SCACA & FECCA
Sponsored by	: Nippon Paint & iMetal



Tree bark is beaten and softened.

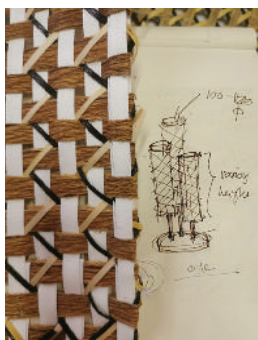

Weaving workshop, Rh. Merunjau Padeh, 4<sup>th</sup> October 2022, Betong.

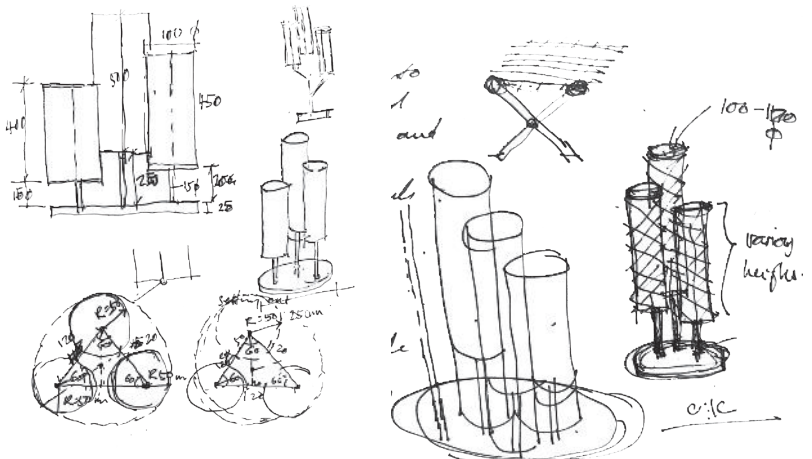

Flash 26 Dec 2022

# BARKING UP THE RIGHT TREE

Contributed by Ar. Ivy Jong

**S**ERUMPUN : “Crafts Across Borders” exhibition is part of the ‘Cultural Assets and Vernacular Material’ programme co-organised by The Glasgow School of Arts and THINK & TINK, supported by The British Council International Collaboration grants. It is part of a year long programme and research that explores sustainability challenges and craft activism in communities across Borneo.

Under SERUMPUN, there are 11 projects in various forms of grass root activism corresponding to their respective contexts in relation to craft categorized into 5 themes; namely, Changing Landscapes, Artisanal Trades, Documentation, Innovations and Youth Education. The 11 groups are from various parts of Borneo Island.

Ranee invited Ar. Ivy Jong and architect Johnson Tan to collaborate for this. Their project “3-Bark” is one of the 11 projects featured under Innovation.

The traditional tree bark, an intrinsic part of Sarawak’s indigenous people’s material culture, was selected by the collaboration team as the material for exploration in view that it faces limitation in its usage these days and the art of bark making is rapidly diminishing among the local indigenous communities.

Traditionally the inner fibre of the tree bark is beaten and softened to use as clothing and as a strong fastening material for farming baskets and mats. The unbeaten bark pieces were used as external and internal wall paneling in traditional longhouses.

The renowned artist Mr. Ramsay Ong uses the bark cloth as his canvas to paint on. Without economic benefits, the art of bark making has become a dying art. To revive the skill of tree bark making, there must be viable usage of this material.

The challenge for the design team, was to change the conventional perception of this traditional material. The objective was to explore the potential of the bark cloth as a contemporary craft material. Working with the Betong women weavers, the team looked at the tree bark material as an alternative craft materials for weaving.

The bark cloth was introduced to several skilled weavers from two longhouses, Rh. Merunjau Padeh and Rh. Mujau Spak in a weaving workshop held at Jawatankuasa Agrokraft Borneo to experiment with different combinations of natural fabrics, a task which was new to them.



The project team (from left) : Rosemarie Wong, Ar. Ivy Jong and Johnson Tan with a prototype of the 3-Bark lamp.

The result from this experiment became the inspiration for the design of the '3-bark' table lamp. As the name suggested, it is a composition of 3 woven lampshades with a tight circumference, set at various heights on an elegant marble base. The decision for a long slender elongated form is to showcase the unique pliability of the bark cloth material.

The veined marble base and polished stainless steel stands provided a strong textural contrast to the rustic weave. The lampshade is a composite woven piece of bark strips and box straps. This is overlaid with even finer strips to create a delicate lattice pattern.

This resulted in a lamp that spreads a warm, intimate glow. The open weave allows the light to filter through and create interesting patterned light and shadows.

The bark tree cloth has always been an understated material, an ancient technique that predates the invention of weaving. With this exercise, the team hopes to showcase its beauty, potential and viability as a craft material.

The main reason for the two architects to accept a 'non-architectural' project, and to collaborate with Datin Rosemarie Wong of The Ranee and their team of weavers was to find ways to revive the dying skill of tree bark making. Finding alternative uses for this traditional material is a good start.

For Johnson Tan it is a more personal journey, as tree bark making was part of his childhood memory from his days growing up in Kpg Abok, Sri Aman.

Ar. Ivy Jong and architect Johnson Tan see the value of exploring craft from an architectural perspective. They want to look at ways to experiment with this material further for architectural and interior uses.

The SERUMPUN : "Crafts Across Borders" exhibition was held at Borneo Cultural Museum until 7<sup>th</sup> Dec and thereafter at THINK & TINK (former Ting and Ting supermarket) until end of Dec 2022.



3-Bark lamp series 01.



3-Bark lamp series 02.

This exercise was made possible in collaboration with Datin Rosemarie Wong of The Ranee, Jawatan Kuasa Agrokrat Borneo and the women weavers of Rh. Merunjai Padeh. and Rh. Mujau Spak.

And with the assistance from:  
Yak Ipin (Kpg Abok) for harvesting and Yak Jinggut (Kpg Sengai) for processing the bark cloth  
Alvin Kho and Aaron Tang of Justlight Enterprise Sdn. Bhd.  
Justin Kho of Umehiko (M) Sdn. Bhd.  
Lin Yuk Chin of Evershine Stainless Steel Enterprise  
Liew Jew Cheung of Renobuilt Intergrated Sdn. Bhd.

END

Co-organized by :



Supported by :



Venues :



## PRACTICAL EXPERIENCE

In the past 3 months, there was an influx of Year 2 students undergoing internship placement in local architecture firms - in this issue, we invited some of them from UNIMAS to share with us their experience; the trials and tribulations of Practical Experience.

### Seau Zi Xiang trained at Design Network Architects, Kuching

A very enjoyable experience, learning much that I would not have learnt in school, especially the site visits with my supervisor, Francis Poh. I helped him with basic drawings; room elevations, toilet details, sections, 3D modelling and more - 'real drawings' done by architects to carry out their work and responsibilities. It was very motivating for me, especially going into Year 3.

I feel that 10 weeks is too short for internship, as there is still much to learn and experience. So much so that I am reluctant to return to class, I am addicted to the sense of pride of seeing the things I drew being built. I now have a clearer understanding of the focus and exploration needed to do well in my course.



### Joanne Ho Chui Ying Year 2 trained at MinWee Architect

Over the 10 weeks at MWA, I have gained a wider perspective of my chosen profession through the constant exposure and training - in this office, there is something new to learn everyday.

One of the more technical things I have learned was construction detailing; from multiple site visits, from conversations with colleagues and project consultants, and involvement in producing detail drawings. I have gained an insight into construction methods, structural detailing and specifications. These skills would definitely prepare me for my upcoming semesters in final year.

I also had opportunity to experience different cultures and architecture; both local and foreign. By visiting different buildings (including a company study trip to Bangkok), meeting new people and making new friends - I gained a wider worldview of the profession. I learned about different office cultures, and how with proper time-management and discipline; a healthy work-life balance is very much achievable for architects, even for the most successful and busiest ones.

I feel that 10 weeks is too short, but even so I have broadened my knowledge on design, philosophy and culture that would be fundamental in developing my own design identity.

### Victor Yau Jun Xian trained at Arkitek JFN Sdn Bhd, Kuching

There are a lot of things and activities I have experienced during my 11 weeks of internship other than just doing Autocad drawings or Sketchup modelling. During my internship, the things I did were more to hands-on activities, for example we collected the bamboos from the roadside's bushes and ready to craft it into something unique.

"Devil is in the details.". For the detailing part, I have learned how the piping system works while cleaning the fish pond filter. Every detailing parts need to be considered to prevent unnecessary incident causes.

Within this 11 weeks, I joined the technical talks held by PAMSC together with my directors to gain more extra knowledge and meet new people especially those experts from other industries. It is also my honour that I was given a golden opportunity by my directors to join them giving talk and sharing session at Architecture Student Workshop in Sibui.

11 weeks of internships is far too short for students to acclimatise to the working world and genuinely be exposed to it. I learned how to work in a team and never be scared to fail or fail trying. A team with good communication will make a project go well. Trial and error of different options is a must to get the best solution especially designing stage. Meanwhile, for work in future, architecture is not just designing, it is more to deal and interact with people, whether they are client, contractors, consultants, or members of the local council.

I am truly grateful to Arkitek JFN Sdn Bhd, especially the principal, directors and also my senior for the opportunities given, for their patience and generosity in guiding me toward a set of professional skills required to practice architecture. Always THINK OUTSIDE THE BOX.







**Wong Jun Xiang Year 2 trained with Intodesign Lab**

Internship at Intodesign Lab was one of the best experiences I could have asked for. Good people, playful projects and a capsule coffee maker. I was mainly involved in design, model making and installation site visits and learned that the essence of their design is often rooted in local culture. Installation projects such as the Moon Pavilion and Gawai Antu exhibitions involve several different communities; each with a different story to tell.

*"Always improvise when things are not as planned"* as my supervisor, Mr. Tay Tze Yong very often says. With the Gawai Antu exhibition project, I produced different sketch designs and renders of it for the client; each of them is carefully considered and presented. On site, the design improvisation continued; solving issues like collapsed bamboo structure, over-bright lighting and more. In the end, I learned about Gawai Antu with its people, reality of transforming design to installation and other skill-sets such as technical and presentation drawings.

I felt the internship was still too short for me to be fully immersed in their larger scale projects which would potentially cover more teaching and learning. Having said that, I learned much more than expected in these 'short' 3-month internship.



**Liew Xin Yi trained at Design Network Architects (DNA), Kuching**

In these 10 weeks of internship. I was grateful for my colleagues' willingness to assist me and impart their expertise and experience. As such, I was able to gain valuable insight into the real world of architectural practice.

Despite the short 10-week internship period, I was involved in a variety of tasks and projects; from tender drawings to staircase details, from submission drawings to tender documents. I assisted in the preparation of mood boards and presentation slides, I visited job-sites where I learned that many real-world issues and obstacles cannot be taught in the courses in university.

For this coming Year 3, I believe I now understand which areas to focus on when creating designs in studio such as research and exploration.

**Hairel Idham Year 2 trained at Rozaini and Ho, Kota Kinabalu.**

I recently just finished my internship and this is a record of my experience at this relatively new practice which was formed in 2020. During my internship, I mostly did 3D modelling of a project using SketchUp, as well as other architectural software. I was told this is an important part of the project as it helps convey our vision of the project to clients more clearly. Working in an office also exposes me to aspects of the architectural practice which could not be taught at school.

My internship could have been better if I had been given the opportunity to visit project and construction sites. Perhaps if the internship period was longer it would have been possible.

Overall, I think that the internship has been very beneficial for me when I continue my 3rd year of degree in architecture as it showed me that an architect is also able to do their work properly while also balancing with the non-architectural things that they enjoy doing on their personal time. This internship programme also helps me in improving my social network for my future by introducing me and getting to know other professionals in the same industry.



**Muhammad Afiq Faisal bin Mustapha trained with JRC Architect**

During my 10 weeks of internship, I helped to prepare the Building Plans for submission to local authorities for a 3-Storey kindergarten at St Thomas's School, Kuching. Some of the lessons learnt in carrying out this task are in relation to the compliance to statutory requirements and technical matters such as fire-fighting and plumbing requirements. Other lessons are design related and include the planning of interiors, building façade, materials and finishes. I was also guided in the integration of civil engineering works in my design, and learned about school / kindergarten spaces.

Ar. Wilson Chang was my supervisor, his philosophy in design is simplicity; he prefers design that sensitive to the local context, environment and especially the needs of the clients. He also concerned about the cost and the maintenance of the building in future. These are principles which I feel I can take on as I embark on my Year 3 of the programme. Though I learned much during my internship, for me 10 weeks of internship is really limited time to learn.





### Lim Joo Wei Year 2 trained with Atelier BT 11

I just finished my internship at the firm nearby my house. The office is quite interesting because it sits inside a library with café. The reason I chose this firm is not only because it is near but also because of its fascinating look within the kampung baru and their projects after I listened to an online talk given by the curator, Mr. Lee Soon Yong during my Year 1.

As a beginner, I was hoping to learn in depth about the technical drawings because that's my weakest part. But during the interview with my supervisor, Mr Lee, I was told that I will be doing more hands-on work rather than drawings and it's totally fine, because working surrounded by village houses was a BONUS for me. Consequently, I met plenty of people from similar fields, got to touch a lot of materials, and learnt to use many tools; from making models, storage boxes to folding doors. My supervisor always reminds me two things, how it grows from ground and how it touches the sky. Therefore, I think I can present my ideas structurally better than before.

Sadly, I didn't manage to work with other partners since they're leaving briefly to pursue their goals. Also, I couldn't make it there when the library reopens later. Hence, I hope that I can meet them again as a group during my next semester break.

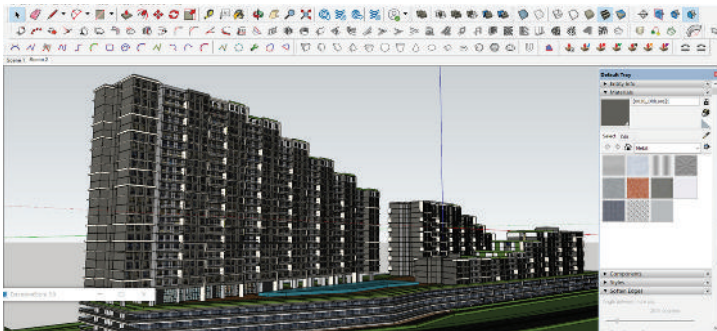

Senawang Rembawang Apartment Sketchup drawing.

### Carol Chong Year 2 trained at Cipta Teguh Architects Sdn. Bhd

In my 3-month internship, I had many eye-opener experiences as the working culture was completely different from what I had learned in university. In university, we were fortunate to have sufficient time to design our studio projects. (which often stops at the design development stage). However, in the real-life architecture, the allocated time-frame is often very short. The office usually takes about a week to design before proceeding to the subsequent stages such as project documentation. While working on the design development stage, I learned many drawing techniques as well as administrative skills such as Architect's Instruction, meeting minutes, schedules of finishes, work orders, and arrange Borang B documents for Authorities submission.

I had to deal with different suppliers or city council officers, which developed my communication and interpersonal skills. This will definitely improve my professional skills in the future. In the nutshell, this program helps me to identify my strengths and weaknesses based on the industry's needs and help me improve my hard skills and soft skills when I graduate from university and look for jobs in the future.

### Nur Nabilah binti Noorzali trained at PDC Design Group, Kuching

I applied to train at PDC Design Group because they work on a wide variety of projects, and I felt that an internship at PDC Design would be a great platform for me to gain deeper insights into the varieties of building typologies in architecture. At PDC, real responsibilities were handed to interns from Day 1, and this is something that I am thankful for as I got to add real value to my team and to experience as much as possible.

I think that the best part of my internship were the site visits, as I have not had the chance to visit a real construction site before. Our supervisor, Ar. Lau Chun Leong, was very helpful in explaining almost every detail of the construction site, guiding us and communicating with us throughout the site visits; we learnt about the construction details, building materials, the façade, and many more. Through their collaborator, IntoDESIGN Lab, we learnt about the design of interior spaces in relation to their clinic project.

The second best parts of my internship were the people and office culture. These are people who work hard, but don't forget to enjoy themselves during the process. Some of my most memorable moments happened outside the office. An event which PDC was involved in: the Moon Pavilion involved 5 universities, which took part in the building process. We also attended a wedding ceremony for one of the staff. It was a nice experience since I also got the chance to learn about other cultures and religions, and at the same time, it taught me about the importance of team bonding in an architecture firm.

Throughout my 10 weeks of internship, all of the staff were friendly and approachable. I was specifically assigned to Cik Hafizah whom I felt really cared for me. As a mentor, she played an important role during my internship giving me a strong sense of satisfaction, and impetus to work and play harder during my internship.

My biggest takeaway are the new long-term relationships and connections that I have forged with my colleagues and fellow interns at PDC. In terms of personal development, I developed stronger self-discipline, self-confidence, mental strength and a deeper passion for architecture.

To conclude, I would suggest that the internship period could be longer, probably 6 months instead of only 10 weeks, which might enable students to see projects throughout the whole process.



**Nurul Batrisyia Year 2 trained at DDR Architects Sdn Bhd**

During my internship, I worked on two waterfront masterplans; one in Lawas and the other at the Medan Niaga, Kpg. Buntal Esplanade. I have learned about developing designs based on site analysis, making many butter paper sketches to refine and improve the design. These sketches were used for reviews and crits with my supervisor, Elandy bin Odita who encouraged me to become more open and explore more. In addition, I get to improve my technical skills as well as have a better understanding of building materials and construction.

This internship experience would have been better if we are exposed to the other aspects of our chosen profession such as the challenges of a practising architect. Perhaps this might be possible if the internship period was longer. However, the knowledge gained during the internship will be useful and reinforce my studio work and future professional work.

I also experienced the joy and pride when our hard work was rewarded with the client's approval of our design, as we did in the Medan Niaga Kpg. Buntal Esplanade project. We only had two weeks to prepare the proposal; it was a satisfying experience.



**Chula Camelia Anak Edwin trained at Konsortium Bumi Sdn Bhd, Kuching**

My internship has been an unforgettable experience.

I was assigned to a variety of tasks; from cross-checking a building defects list to CAD drafting for different projects and urban planning. I joined design discussions with their clients and performed for the company's 16th-anniversary dinner!

The projects I worked on taught me about spatial planning, circulation, and the Sarawak Law Ordinance. I was exposed to various projects at different phases which taught me about the many stages of a project. I also developed self-growth in terms of discipline and time management, I learned to stay motivated by keeping a learning mindset. This internship helped me understand what is it to be professional in my work.

However, 3 months of the internship was not enough to actually experience a project. I had hoped for more interactions with the community rather than just office work. The lessons I learned have prepared my expectations for my 3rd year of architecture degree and working life, especially in the technical parts. My favorite lesson was how to have fun in architecture.

**Gladys Ankin Anak Maynet trained at PDC Sdn Bhd, Kuching**

During the 10 week internship, I have gained more knowledge and technical skills than I had expected. My colleagues were so friendly and helpful especially in explaining the tasks that were assigned to me.

My supervisor taught me many little details that I would normally have missed – from 3D forms to construction sequences, from good teamwork to work-life balance. I learned how to prepare a drawing set and the slide presentation for a meeting, I joined my colleagues in their visits to the City Council and attending site visits of their ongoing projects.

I think that 10 weeks was not enough for us as an Architecture students to complete the Industrial Training, Industry-based student training has been very rewarding and a great benefit to us; providing excellent exposure to the real work environment. As I completed my internship and as I became familiar with the working environment, I learned to be more independent, disciplined, responsible and take care of my time management that could prepare myself on my Final Year Semester and my job in the future.



**Nur Iffa Zalika Binti Abdul Karim trained at MinWee Architect**

My team welcomed me with open arms from the start of my internship, my colleagues were invested in my growing and believed in me. I also have my friend, Joanne, who always lend me her hand and made sure I was doing well. We also had Dory, the cat who become the adorable therapist at our office.

My knowledge and skill grew significantly over the 10 weeks. I picked up many skills along the way, guided by my colleagues, technical proficiency in software such as AutoCad and SketchUp. We also have opportunities to learn outside of the office, particularly during site visits and, most incredible, during the 6 days study trip to Bangkok, Thailand, where we get to see and learn about the society and culture in Bangkok. There is a photo of Ar. Min explaining to me the materials used at the Windshell Naradhiwas, as well as a photo of us exploring more places in Bangkok.

I really grateful for everyone's help, and I knew I was in the right place right away. From lunch breaks to tea time, I got to know my team better as we shared stories and made memories together.

# LOVE IN FOREIGN CLIMATES

**P**AMSC has hosted many study trips in the past 2 decades, most of which were organised by Ar. Ng Chee Wee who is fueled by his love of travel, culture, cuisine and architecture. These series of love portraits are a selection from several of these trips; a departure from streetscapes and buildings, and perhaps a result of too many days away from the ones we love.



We came across this park on one of our walking tours; Sara said it reminded her of the Paris parks she had seen in movies. It is clear why - the tree-lined avenues with lawns in between them, vistas guided towards fountains and statues, the crunchy gravel underfoot and couples cuddling on park benches. Clear signs of the French influence in Shanghai's past - so it seemed appropriate that we would meet this spritely couple; not young in years but still youthful in their step. Sara took this series of shots; as they practiced - coaching and encouraging each other - quite oblivious to the crowd which gathered to watch them; envious of their dancing skills and also their obvious enjoyment of each other's company.

- FuXing GongYuan, Shanghai



Young love has winged feet.

- Red Fort, Agra



*Love in foreign climates*

On a distant Sunday, these two people caught my eye. How he listened as she spoke, and never took his eyes off her.

Now years later, I wonder he still has eyes only for her. (and listen when she speaks).

- Florence.



Their hands were not touching, but their heartstrings must be intertwined like their feet.

- As the bus slowed to round the corner at the United Nations Memorial in Casablanca.

# KEY MILESTONES FOR NEW PAMSC CENTRE

2019	Oct	PAMSC Committee starts looking for a new premise due to the limitation of existing centre at Queen's Court.
2020	Jan	First meeting by <b>Ar. Ivy Jong</b> together with Office Bearer then and some Past Chairmen to prepare the paper to PAM Council.
	Sept	PAMSC presented the proposal to PAM Council Meeting, more info was requested.
	Nov	A revised proposal was presented to PAM Council Meeting again. PAMSC was requested to provide other options for consideration.
2021	Jan	Proposal for Saradise had been approved in principle by PAM Council. PAMSC was requested to submit evaluation report.
	Feb	<b>Ar. Ivy Jong</b> presented the proposal for Saradise to PAM Investment Committee. PAM Council agreed to the purchase.
	Mar	<b>Pusat Binaa (PBSB) confirmed the purchase for Saradise.</b>  <b>Sublot 11 (Block A1) Saradise, Kuching</b> <b>No. of storey = 3</b> <b>Floor area = approx. 6,800 sqft. (9.5m x 23m)</b> <b>Lv 1 &amp; 2 are with existing tenants</b> <b>Lv 3 – PAMSC Centre (approx. 2,300 sqft.)</b>
	May	PAMSC Working Task Force Team was formed. Lead by <b>Ar. Noraini</b> to look into the renovation of the New PAMSC Centre.
	Jun	PAMSC called for members to submit expression of interest as Consultant Architect for the renovation works. Interview was carried out with those submitted and PAMSC decided to award to <b>IDC Architects Sdn. Bhd.</b>
	July	IDC presented their schematic design to PAMSC Working Task Force Team.
	Sept	Tender called for contractors. Price came in was over the budget.
	Dec	Revise of design & seeking for sponsorship.
2022	Feb	Contract for renovation works awarded to <b>Lian Ho</b> and commenced.
	July	Works completed & handled over to PAMSC. PAMSC moved to Saradise officially on 30 <sup>th</sup> July.
	Aug	<b>PAMSC Saradise Soft Launching with our industry partners and members.</b>
2023	Feb	PAM 9 <sup>th</sup> Council Meeting in PAMSC Saradise Kuching.
	4 <sup>th</sup> Mar	<b>PAMSC Saradise Official Launched by YB Dato Sri (Prof) Dr. Sim, Minister for Ministry of Public Health, Housing &amp; local Government Sarawak (MPHLG).</b>

# CONSTRUCTION UPDATES

Reported by the overqualified IOWs: Annie, Kong YW, Ivy & Lau CK (On behalf of PAMSC Building Committee)

Upon finalising the purchase of the 3-storey corner unit at Saradise by Pusat Binaan Sdn Bhd, PAMSC then embarked on a journey in June 2021 to set up the PAMSC new premise.

We teamed up with *IDC Architects Sdn Bhd* and later awarding the works to *Lian Ho Furniture & Interior Works* as the Contractor for the project. The project commenced on 10<sup>th</sup> February 2022, with site meetings every Thursday and finally the keys was handed back over to PAMSC on 19<sup>th</sup> July 2022.

The new premise is also fortunate to receive great support and product sponsorship from our industry partners. And we look forward to continuous support and attendance as we now have a bigger space for many more activities to come.

We now have a month to move and get the centre ready. Till then, we look forward to welcoming everyone to our new address:

**Pertubuhan Akitek Malaysia Sarawak Chapter**  
 Level 3, Sublot 11,  
 Block A1 Saradise,  
 Jalan Stutong,  
 93350 Kuching, Sarawak

## April 2022



MAIN ENTRANCE - Oxidized metal door frame with delivery counter in position.



TOILET - Face brick with paint finish for hand wash basin.



M&E WORKS - Installation of air-cond & wiring cabling above ceiling completed.



SEMINAR ROOM - Installation of plywood sliding panel with perforations motif.



RECEPTION & LOUNGE - Mild steel shelving installed next to entrance.

## June 2022

Concrete floor installation. (07.06.2022 – 09.06.2022)



Shower glass installation. 12.06.2022



Furniture & lighting installation. (13.06.2022)



Built-in furniture being mobilized to site. (09.06.2022 – 10.06.2022)



July 2022

Completion of renovation work and handover. (19.07.2022)

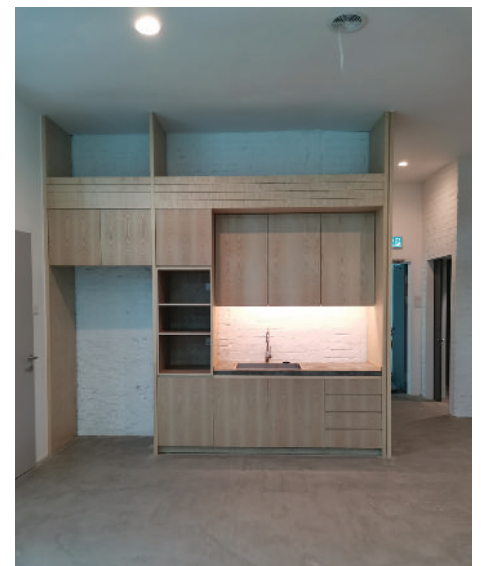
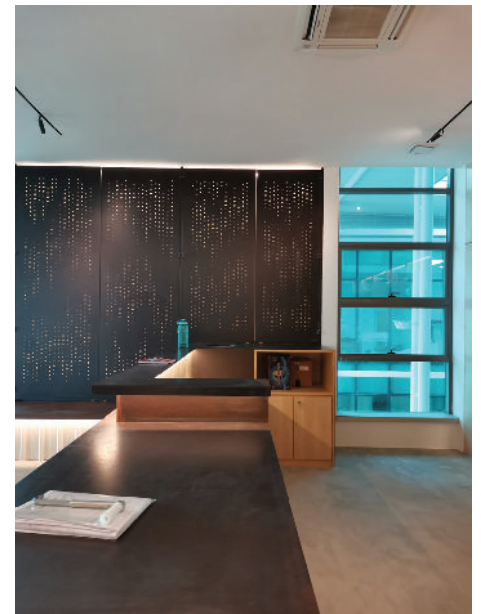

Main Contractor : Lian Ho Furniture & Interior Works  
Type Of Work : Interior Renovation & Fitout Works  
Commencement Date : 10<sup>th</sup> February 2022  
Completion Date : 6<sup>th</sup> July 2022

# SOFT LAUNCHING OF NEW CENTRE ON THE 19<sup>TH</sup> OF AUGUST 2022, FRIDAY 430 P.M.

## PARTY PROGRAMME

- 4:30 p.m. - arrival of invited guests and members
- 5:00 p.m. - serving of light refreshments and drinks
- 5:25 p.m. - setting off of firecrackers at the 5-foot way
- 5:30 p.m. - opening remarks by Vice-chairman Wee Hii Min
- 5:32 p.m. - welcome speech by Chairman Chai Si Yong  
\* short briefing about the purchase, design, construction and completion of the New Centre. He invited local industry partners to take up advertisement panels in the centre, and to hold their events in the new centre.

- 6:00 p.m. - acknowledge and congratulate new Part III passing candidates, and invite them to join PAMSC committee and sub-committees
- 6:05 p.m. - first keg of beer runs out
- 6:10 p.m. - party resumes when food and drinks are replenished as many guests arrive at the centre after work.
- 7:00 p.m. - conclusion of office warming party as the 120 guests leave with gifts from PAMSC.



5:25 p.m.



Catering by Jordan's Signature.



The new Centre is large enough for guests to find a quiet corner to chat.



Ivy Jong, Law Kim Chui and Kelvin Hong.



Some guests prefer to congregate in the Resources Room.



New Architects receiving gifts to recognise their success in the Part 3 exams.



The turnout of guests was more than expected.



Tay and Min with their students from UNIMAS.



Familiar faces re-surface after a 2-year absence.



The new Centre project management team: Kong Yean Wei, Annie Narroden, Lau Chee Kiong and Ivy Jong.



Ar. Chee Wee announcing the sale of Dr. John Ting's book.

Image Courtesy of Sean Wee & Ivy Jong



# PAMSC CENTRE OFFICIALLY OPENED!

On 4<sup>th</sup> March 2023, PAMSC received a warm visit by our Deputy Premier and Minister for Ministry of Public Health, Housing & Local Government, YB Dato Sri Prof. Dr Sim Kui Hian. YB Dato Sri spent the morning with us to officially launch the PAMSC Centre at Saradise Kuching. The ceremony was witnessed by our members and friends, Office Bearers of PAM and directors from Pusat Binaan Sdn. Bhd. from KL.





# Nyih Hor Moh... Singkawang

*("How are you" in Hakka, a local dialect commonly spoken in Kota Singkawang)*

## Borneo City Forum

In conjunction with the 21st anniversary of City Day, Kota Singkawang celebrated with 10-day festival which included leisure events, musical performances, an expo and sports tournaments. One of the key events was the 1st Borneo City Forum (BCF) held on 15<sup>th</sup> October 2022 at Swiss-Bellinn Hotel, Singkawang. The theme for the forum "One Vision One Borneo" was in-line with the rapid development of cities in Borneo Island after the announcement of the new capital city in Kalimantan.

BCF was jointly organized by Ikatan Arsitek Indonesia Kalimantan Barat (IAI KalBar) and Pemerintah Kota Singkawang. Wali Kota, Tjhai Chui Mie, S.E., M.H., believes in working together with architects as city designers in uplifting the well-being of the built environment and people in Kota Singkawang. BCF was designed as a platform for discussion and networking with cities in Borneo for better understanding and potential collaboration between cities. The forum was conducted in two parts. The first part consists of presentations by renowned architects and researchers. The second part was presented by representatives from architectural institutes around the region.

PAMSC is honoured to be invited as one of the speakers for BCF. We took this opportunity to introduce our chapter to participants of BCF, sharing our initiatives and collaboration with our members, government, industry partners, and the public.



*Welcoming Dinner with Wali Kota Singkawang (in her red sneaker) and speakers for Borneo City Forum on Friday evening.*



*Group photo of guests and speakers for BCF.*



*BCF was held in Swiss-Bellinn Hotel Singkawang, attended by the Mayor of Singkawang, the Mayor of Pontianak, the Mayor of Banjarmasin, representatives from government sectors, members of IAI, university students & other stakeholders.*

**Borneo City Forum**  
*'One Vision One Borneo'*

Wadah diskusi untuk melihat arah pembangunan di wilayah Borneo serta mencapai sebuah kesepakatan tentang bagaimana mewujudkan visi di masa mendatang tentang wilayah Borneo.

Sabtu, 15 Oktober 2022 (08.00 - 15.00 WIB)

BALLROOM HOTEL SWISS-BELLINN SINGKAWANG

**MARASUMBER**

 Dr. H. Bima Arya S., S.Hum MA <small>(Wali Kota Singkawang)</small>	 Ar. Firman Herwanto, IAI <small>(Praktik Arsitek)</small>
 Dr. Baskoro Tedjo MSEB, IAI, AA <small>(Dokter Spesialis dan Akademisi)</small>	 Ar. Chai Si Yong <small>(Dosen di AMI Sarawak, UPM)</small>
 Ar. Budi Pradono, IAI <small>(Praktik Arsitek)</small>	 Ar. Wahyullah Bandung, IAI <small>(Praktik Arsitek)</small>
	 Ar. Estar Putra Akbar, IAI <small>(Rencana Kalimantan Barat)</small>

IKATAN ARSITEK INDONESIA KALIMANTAN BARAT

**NARA HUBUNG**

Rissa Rizki Amalia (08132948543)  
G1 Pronevi (08199767379)  
Siska Permelita Sari (08152885447)  
R. Wihla Alhamdani (08191603321)

*The event poster for Borneo City Forum.*

## Journey to the South

This is my first trip to Kalimantan, a place that is so near to us yet so far (long hours) to travel. Due to the last minute arrangements, I decided to take the five and half hour road trip, instead of flying through multiple cities to reduce some carbon footprint. The Customs and Security point at Biawak and Aruk was very smooth. Other than the narrower road from the Aruk border onwards, the rest are quite comfortable.

Kota Singkawang is about half the size of Kuching in population, covered by mostly low-rise buildings over a gridiron city plan. It is a city with the most Chinese population in Indonesia and the Hakka dialect is widely spoken among the Chinese. Kota Singkawang is also known as the "City of Thousand Temples" where buildings with Chinese art and sculptures are easily found around the city.

Kota Singkawang is also famous for its unique local food, Hakka "Choy-pan" (菜粿) is one of the best for me. It is traditional Hopoh (河婆) Hakka's steamed vegetable dumplings. Fresh jicama or chives cooked with dried shrimp, covered in a thin layer of rice skin. The best way to eat the Choy-pan in Singkawang is to eat it together with the local "kopi".



Hakka "Choy-Pan" and local cinnamon coffee.

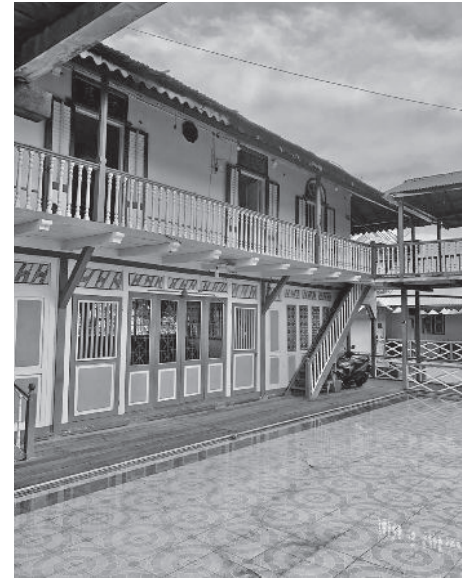

"kai fon" (chicken rice) can hardly see the rice.

Traditional Chinese courtyard house of Tjhia family.

## A fruitful journey

After 4D3N in Kota Singkawang, I am amazed by the similarities between Kota Singkawang and Kuching; in dialect, food, culture and multi-racial living among the people. The forum is the first physical event by IAI, and many representatives from outside of West Kalimantan travelled long hours to support the event (I travelled the least). It is also an important platform to connect cities on this island to share knowledge and collaborate with each other for the benefit of all. Hopefully, there are more connectivity among the cities to bring us closer physically or virtually.



END

Google Maps shows the travel distance and time from Kuching to Kota Singkawang.

An idea which I saw at the back page of the AJ (Architect's Journal, RIBA) many years ago, in which architects describe their day in a series of photographs (Polaroids) - some depict structured time management in neatly cropped snapshots while others show a chaotic day rushing from airport to local council to site and back again in blurry images taken on the run.

Our readers are invited to submit their 'day's experiences' as well - email to [intersection.editorial@gmail.com](mailto:intersection.editorial@gmail.com)

## WHAT DO ARCHITECTS DO ALL DAY? 2/12



6.45 a.m. game of tennis with Kelvin and Ni at the club before Tay collects me for our studio at UNIMAS.



9.30 a.m. Crit at UNIMAS with Ar. Nurina and Ar. Abg Razali; who were invited to review our students' work.



11.30 a.m. once a week we take turns to cook lunch at the office.



1.30 p.m. Hotel refurbishment project - site visit with sub contractors to finalise M&E routing.



2.30 p.m. TV room extension - inspecting recently struck concrete wall.



3.30 p.m. - afternoon tea with the MD.



5.00 p.m. COVE 55; a trip to the seaside with mom, to check defects rectification.



6.30 p.m. last minute tidying up before dinner, Dory stands guard.



9.00 p.m. doodling after dinner, listening to Stephen Fry on Qi

# WHAT DO ARCHITECTS DO ALL DAY? 3/12

*This section attempts to sum up the architects' busy day in a series of snapshots - this is Ar Chai Si Yong's contribution this issue. For the next issue, we nominate Ar Leong Pik Shia.*

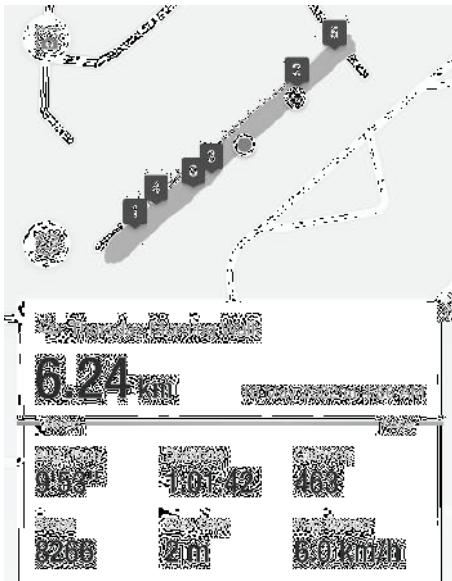

5:57 a.m. Completed 60 mins walk.



7:25 a.m. Laksa with SL after sending the kids to school.

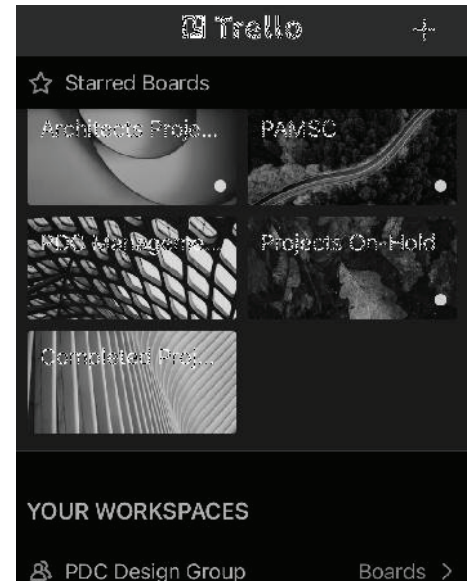

10:16 a.m. Going through & updating task list for the week.



11:45 a.m. Follow Tay to check out the mock up from Ah Jong.



13:35 p.m. Raya luncheon at Fi's house.

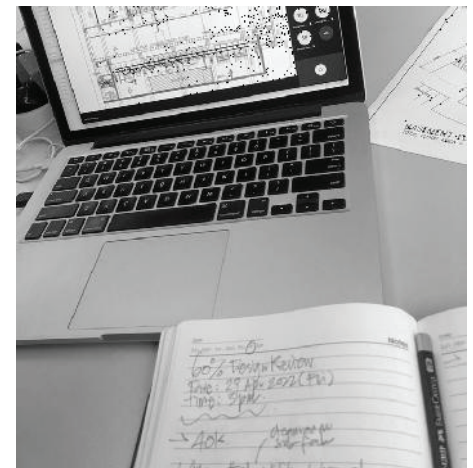

15:05 p.m. Online project design review.



16:40 p.m. Coffee break



19:45 p.m. Meeting with my favourite people.



21:25 p.m. Reached home and realized both cutie pies still awake.

# WHAT DO ARCHITECTS DO ALL DAY? 4/12

*This section attempts to sum up the architects' busy day in a series of snapshots - this is Ar Leong Pik Shia's contribution this issue. For the next issue, we nominate Ar.Ivy Jong.*



**5:45 a.m.** Run around Cat city with running buddies.



**7:15 a.m.** Energy loading....A bowl of hot soup and cup of teh 'O' to start the day.



**8:00 a.m.** Good morning 'Ong Lai'. Watering garden plants.



**9:30 a.m.** Virtual meeting & physical works.



**2:00 p.m.** Site meeting & inspection while enjoying the panoramic view of Kuching



**4:30 p.m.** Savoring 'Teochew' steamed rice water cake (chwee kueh) (水粿) at Jalan Padungan.



**6:30 p.m.** Soaking in the water, a great way to boost recovery after a long busy day.



**7:30 p.m.** Sometimes..... Be grateful to still be standing and celebrating another blessed year of life!



**11:30 p.m.** Good Night

# WHAT DO ARCHITECTS DO ALL DAY? 5/12

*This section attempts to sum up the architects' busy day in a series of snapshots - this is Ar Ivy Jong's contribution this issue. For the next issue, we nominate Ar. Alfred Ting.*



6:30 a.m. Watering my salads.



7:30 a.m. Breakfast with buddies.



9:00 a.m. Heading out of Kuching, for once, the road is clear!



10:00 a.m. 'Hakka' translator for client to site clearing contractors.



1:00 p.m. Discussion with CSR team over lunch.



2:30 p.m. Overseeing setting out for a CSR project at Greccio retreat centre.



6:30 p.m. Discussion with clients over main course.



9:00 p.m. Went over to catch up with my people and desserts!



11:00 p.m. Good Night.



# WHAT DO ARCHITECTS DO ALL DAY? 6/12

*This section attempts to sum up the architects' busy day in a series of snapshots - this is Ar. Alfred Ting Sze Nang's contribution this issue. For the next issue, we nominate Ar. Angel Wong.*



8:00 a.m. Feeding neighbouring cats



9:30 a.m. Discussion with colleague for everyday tasks



10:30 a.m. Working in office as usual



11:30 a.m. Visit site with client



12:30 p.m. Lunch Break



2:00 p.m. Selection of furniture for client bangalow



3:30 p.m. Site visit no.2



6:00 p.m. Celebrating Mum's Birthday



7:00 p.m. Exercise

# WHAT DO ARCHITECTS DO ALL DAY? 7/12

*This section attempts to sum up the architects' busy day in a series of snapshots - this is Ar. Angel Wong's contribution this issue. For the next issue, we nominate Ar. Wong Siew Ling.*



4:45a.m. Preparing breakfast for family - carbo. + protein + vege.

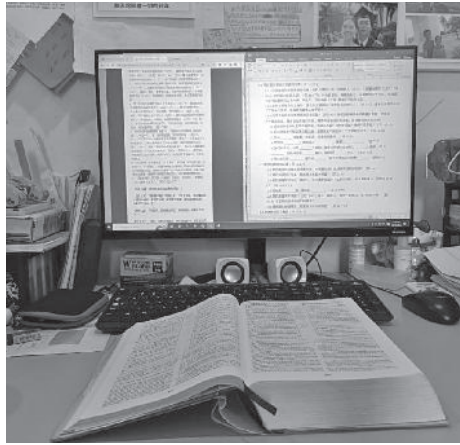

7:00a.m. Praying and studying the Bible before starting the day's work.

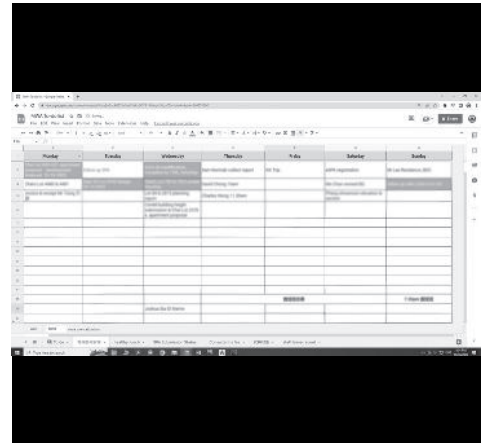

7:30a.m. Checking & updating task list for the staff within the week.



9:00a.m. Project review and planning.



11:00a.m. Site inspection & coordination with contractors.



15:00p.m. Coffee or tea break (^v^)



17:00p.m. 刘耕宏本草纲目减脂操 training.  
New challenge: 2 mins 龙拳 🐉🐉



18:00p.m. It's playtime!



19:00p.m. Guide kids' homework while planning tomorrow's work.

# WHAT DO ARCHITECTS DO ALL DAY? 8/12

*This section attempts to sum up the architects' busy day in a series of snapshots - this is Ar. Wong Siew Ling's contribution this issue. For the next issue, we nominate Ar. Tay Buang Chuan*



5:30a.m. Joy of worship.



7:00a.m. Joy of Nature.



8:00a.m. Joy of life partnership.



9:00a.m. Joy of freedom-Projects coordination at the finger tips.



11:00a.m. Challenges of design and construction, and the joy of creation.



2:00p.m. Joy of teamwork Projects monitoring & design reviews.



3:00p.m. Sharing the joy of life with colleagues.



4:00p.m. Joy of friendship.



19:30p.m. Joy of praying together in the faith community.

# WHAT DO ARCHITECTS DO ALL DAY? 9/12

*This section attempts to sum up the architects' busy day in a series of snapshots - this is Ar. Tay Buang Chuan's contribution this issue. For the next issue, we nominate Ar. Noraini Narodden.*



*5:45a.m. Day Starts with a few pages of soft 'bread'.*



*6:30a.m. Sending kids to school.*



*8:30a.m. Site visit with Kampung Adidas.*



*11:30a.m. Treat myself with local delicacies.*



*12:00noon Back to office or home?*



*2:00p.m. Tutorial hours!*



*4:00p.m. Interns 'stealing' my workstation!*



*8:00p.m. Sports time....*



*11:00p.m. Day ends with another few pages of soft 'bread'.*

# WHAT DO ARCHITECTS DO ALL DAY? 10/12

*This section attempts to sum up the architects' busy day in a series of snapshots - this is Ar. Ar. Noraini Narodden's contribution this issue. For the next issue, we nominate Ar Amanda Lau.*

## A Day In A Life of ANN



*7.30am: Watering the plants.  
Coffee. Gathering Thoughts.*



*8.30am: Briefing. Checking. Delegating.*



*10.30am: Meeting.  
Deliberating. DEADLINES.*



*12.30pm: Lunch Box.  
Netflix. Chill.*



*2.00pm: Site. Boots. Sun Block.*



*5.00pm: Crit. Clearing Table.  
Tomorrow's To-Do List.*



*6.45pm: Run. 3km. Run.*



*7.30pm: Group Workout. Stretching.  
Sweat it out.*

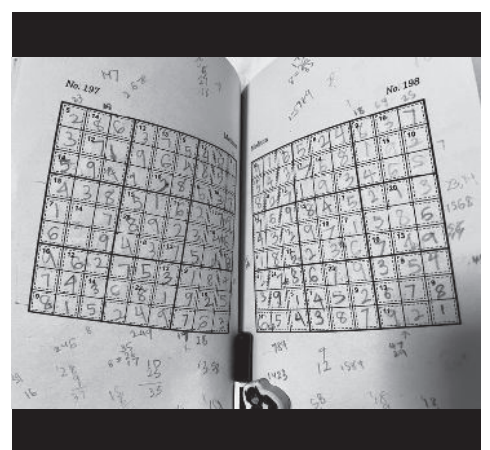

*10.00-11.00pm: Clearing The  
Mind. Sudoku. Bedtime.*

# WHAT DO ARCHITECTS DO ALL DAY? 11/12

*This section attempts to sum up the architects' busy day in a series of snapshots - this is Ar. Ar. Amanda Lau's contribution this issue. For the next issue, we nominate Ar. Freddie Lo*

## A Day In A Life of MANDY



8.30am: Breakfast.



9.00am: Morning Discussion.



10.00am: Site visit.



12.00pm: Lunch.

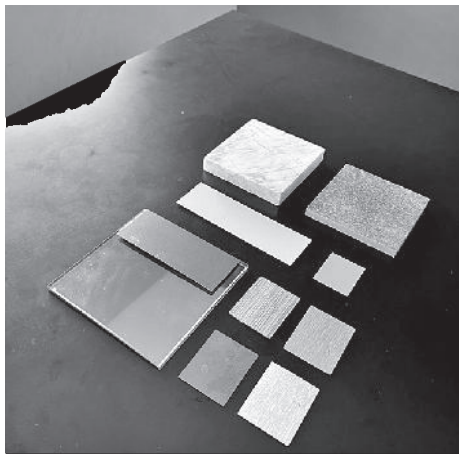

2.30pm: Preparing Material Samples for Client's Approval



3.30pm: Group discussion with colleagues, Projects update.



6.00pm: Chill session with friends.

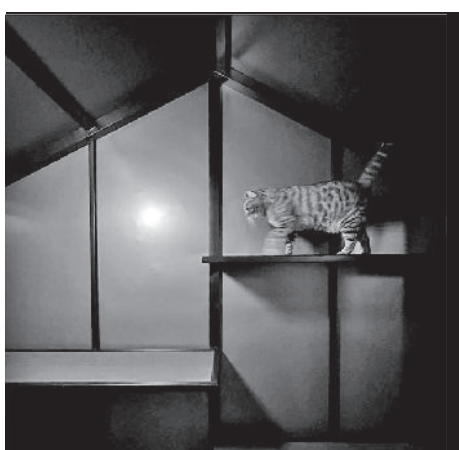

8.00pm: Spending some quality time with my cats.



10.00pm: Me Time.

# WHAT DO ARCHITECTS DO ALL DAY? 12/12

*This section attempts to sum up the architects' busy day in a series of snapshots - this is Ar. Ar. Freddie Lo's contribution this issue. For the next issue, we nominate Peng Hui Lee.*



**7.30am: Green finger training in progress.**



**8.30am: Walking meeting with colleagues.**

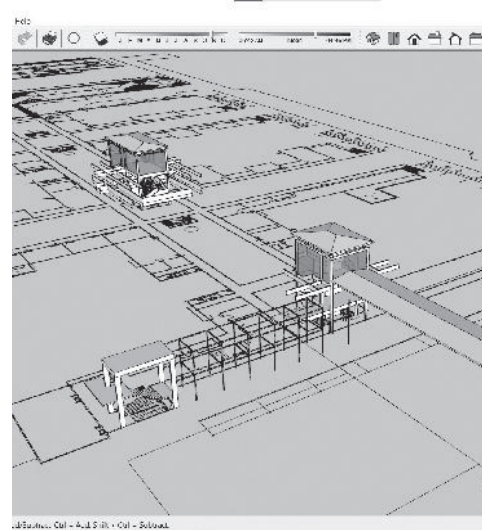

**10.30am: Designing lift motor room.**



**12.30pm: Lunch hour read.**



**2.00pm: How come the wall senget one...?**



**3.30pm: Which colour to choose for the steel...?**

**7.01** km

You've already burnt off 1,955 kcal this week through exercise. Weigh yourself to check your progress.

Measure

Duration <b>01:02:12</b>	Calories <b>574</b> kcal
Avg pace <b>8'52"</b> /km	Avg speed <b>6.76</b> km/h
Avg cadence <b>161</b> steps/min	Avg stride <b>70</b> cm
Steps <b>10,061</b> steps	Avg heart rate <b>169</b> bpm

**5.30pm: Run, Freddie, Run.**



**8.30pm: Growing baby scoby.**



**10.30pm: Me Time.**

# COMING SOON !



If you have a project you'd like to share, email it to us at [intersection.editorial@gmail.com](mailto:intersection.editorial@gmail.com)

Flash 27 Jan 2023

## OUR PARTNERS



Contributing to Architecture in Sarawak

We specialize in a variety of residential and commercial glazing systems

- INFINI
- SOLIDE
- EUROGROOVE
- BI-FOLD & Laminated Glass

**Seng Lee Glass Sdn. Bhd.**  
成利玻璃有限公司

Lot 2005, Jalan Semaba, Batu 5, 93250 Kuching, Sarawak. (387670-T)

☎ 082-576969 ☎ 082-579955

✉ [info@sengleeglass.com](mailto:info@sengleeglass.com)

🌐 [www.sengleeglass.com](http://www.sengleeglass.com)

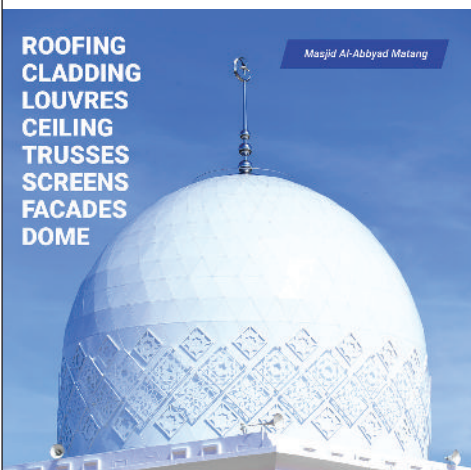

Masjid Al-Abbyad Matang

ROOFING  
CLADDING  
LOUVRES  
CEILING  
TRUSSES  
SCREENS  
FACADES  
DOME



Kompleks Islam Sarawak

**IMETAL DOME STRUCTURAL & FINISHING**

Masjid Al-Hidayah Bako

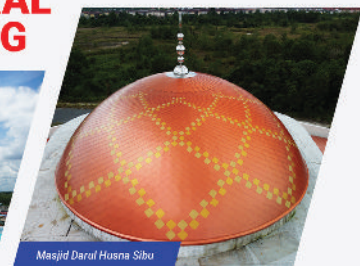

Masjid Darul Husna Sibn

Kuching Tel : +6010-982 0235 / +6082-496336

Bintulu Tel : +6012-852 8712

[enquiry@imetal.com.my](mailto:enquiry@imetal.com.my)

[www.imetal.com.my](http://www.imetal.com.my)



# OUR PARTNERS



LUSH

dasso

Armstrong FLOORING

Interface

**GL BALNIAGA**  
A Brand You Can Trust

- Interlocking Vinyl Flooring
- Sport Flooring
- Bamboo Outdoor Decking
- Vinyl Sheet
- Gym Flooring
- Artificial Grass
- SPC Flooring
- Carpet Tile
- PVC Ceiling & Wall Paneling
- PVC Decorative Panel



L&C GLOBALNIAGA SDN BHD



www.globalniaga.net

+6082 333 929 +6082 336 929 kenlaw@globalniaga.net

Lot 1618, Sublot 10, Lorong 6A, Jalan Setia Raja, Muara Tabuan Light Industrial, Phase 2, 93350 Kuching, Sarawak, Malaysia.

## LEADING PORCELAIN CERAMIC TILE BRAND IN MALAYSIA

**KINGRES**  
BEAUTIFUL TILES FOR LIFE

Contact us for more information:  
KINGRES SARAWAK SDN BHD  
112-010, Kompleks Pangsapuri, 112-010, Jalan Pangsapuri, 93000 Kuching, Sarawak  
Tel: +6082-430 867/437 817

**SIMPLICITE**  
Light Grey (600x600mm)

Follow us!  
 @kingres  
 @kingresides  
 @kingresTiles

## THE SMART PROFESSIONAL' CHOICE FOR TILE ADHESIVES!

**Davco** BUILDING TRUST **Sika**

SIKA KIMIA SDN BHD  
Level 3, No. 42, Block C1, Saradise Kuching, 93350 Kuching, Malaysia.  
Tel / Fax : 082-288 766  
www.sika.com.my

**UNILOK**  
STEEL ROOF & CLADDING

Sarawak Shooting Range

**UGI**  
ONE-STOP CENTRE FOR STEEL ROOFING SOLUTIONS

UGI offers warranty against perforation due to corrosion for your roofing & walling application

UP TO **25 YEARS\***  
\*warranty T&C apply

# ALL-WEATHER WALL CLADDING

"The IKEA Blue coated steel is from our premium high durable **envioSHIELD** series which provides a plethora of benefits when applied to architectural surfaces.



## FOR FLAWLESS WALLS AND FRESH AIR INDOORS

**NEW**



CLEAN AIR TECHNOLOGY



ODOUR-LESS COMFORT



LUXURIOUSLY SMOOTH



COVERS HAIRLINE CRACKS

For further enquiries, contact us today!

☎ 082-339958

📠 082-411863

✉ info@jotun.com.my

🌐 www.jotun.com.my

## Armstrong Flooring

Maximum flexibility and value for

### Healthcare, Education, Residential & offices etc.

**GLOBALNIAGA**  
A Brand You Can Trust

(Sarawak Exclusive Distributor)

☎ +6082 333 929

☎ +6082 336 929

📧 kenlaw@globalniaga.net

🌐 www.globalniaga.net

📍 Lot 1618, Sublot 10, Lorong 6A, Jalan Setia Raja, Muara Tabuan Light Industrial, Phase 2, 93350 Kuching, Sarawak, Malaysia.



## Practicality and Convenience at Your Finger Tips: The All-New Lysaght BIM Object Collection



Download Today!



Single-layer metal cladding BIM objects

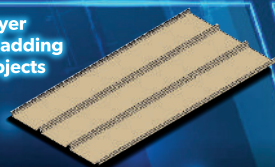

Performance-driven built-up systems

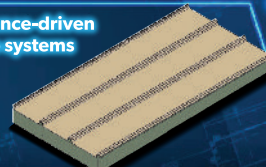

With essential flashing and capping detailing

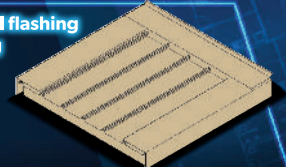

NS BlueScope Lysaght (Sarawak) Sdn Bhd

☎ +6082-333-621

🌐 www.lysaghtasean.com